

Stainless Steel Horizontal Pumps

RAE's GTPH Series horizontal end suction multistage pumps are intended for industrial use to carry clean water and fluids without abrasives.

Reliable, quiet, and compact, these non-self-priming pumps feature a coupling connection between the pump shaft and motor shaft.

Stainless steel construction of all parts in contact with pumped fluid ensures corrosion free operation.

All stainless construction and single phase motors are available as options; consult factory for more information.

Applications:

- Industrial circulation systems
- Wash systems
- Pressure boosters
- Liquid transfer
- Agricultural irrigation

MOTOR

Nominal speed: 3500 rpm at 60 Hz
Standard voltage: 3 phase; 230V/460V
Protection class: IP54
Insulation class: F



MODEL CODE

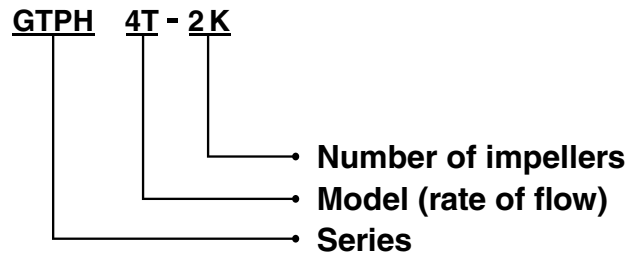
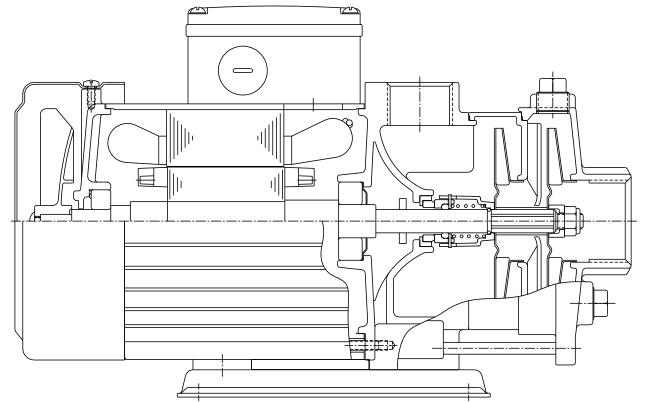

OPERATING LIMITS

Ambient temperature: Max 104°F
Liquid temperature range: 32°F to 194°F
Flow: 8 gpm to 36 gpm
Head: 25' to 240'
Operating pressure: Max 142 psi
Inlet pressure: Max 85 psi

PERFORMANCE CURVES

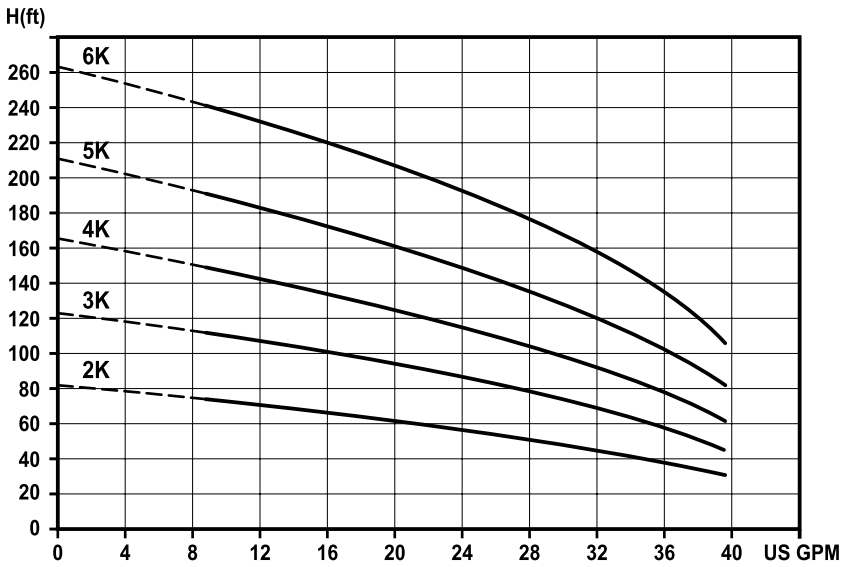

ELECTRICAL DATA

Model	Amps (A)		Power (hp)
	230V	460V	
GTPH4T2K	3.0	1.7	0.5
GTPH4T3K	4.0	2.4	0.75
GTPH4T4K	4.5	2.9	1.0
GTPH4T5K	6.2	3.5	1.5
GTPH4T6K	7.7	4.5	2.0

DIMENSIONS — WEIGHTS

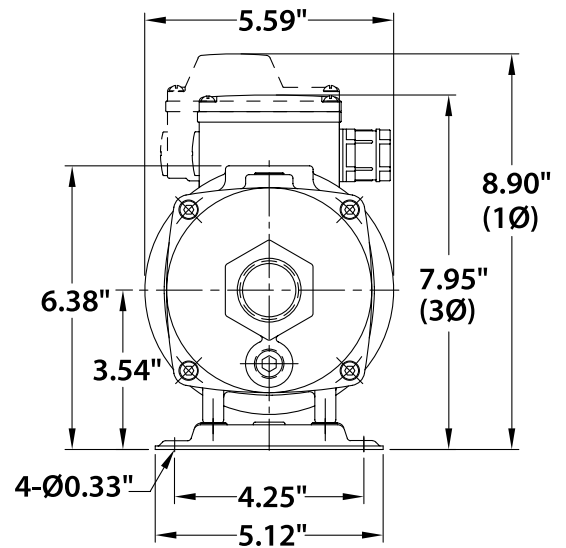
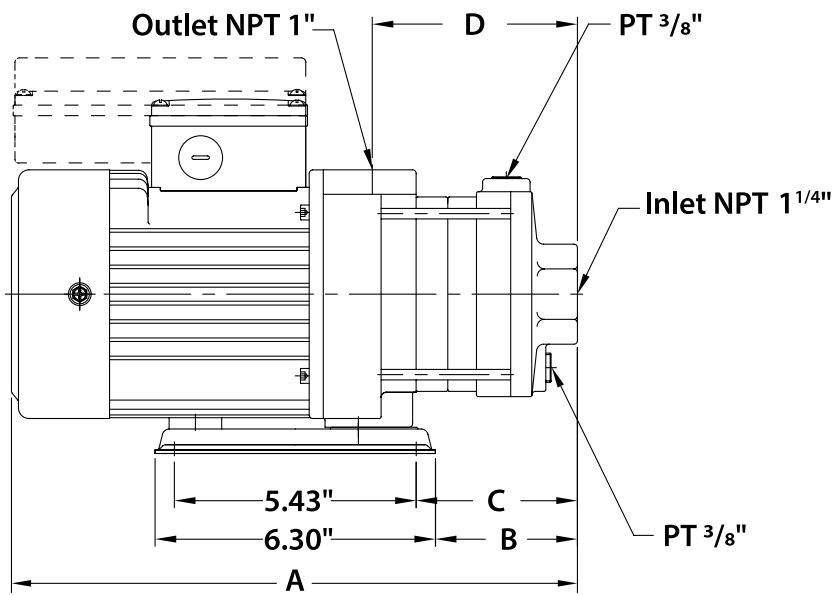

Model	A (inches)	B (inches)	C (inches)	D (inches)	Weight (pounds)
GTPH4T2K	12.36	2.83	3.27	4.29	25.8
GTPH4T3K	15.00	3.90	4.33	5.31	29.3
GTPH4T4K	16.06	4.96	5.39	6.38	31.1
GTPH4T5K	17.13	6.02	6.46	7.44	31.3
GTPH4T6K	19.37	7.09	7.52	8.54	35.5