

# Operation



## SaniForce™ 1040e Electric-Operated Diaphragm Pump

3A3167J  
EN

For fluid transfer in indoor sanitary applications. For professional use only.



### Important Safety Instructions

Read all warnings and instructions in this manual. **Save these instructions.**

*For maximum operating pressures, see the Performance Charts on pages 46–49. See pages 6 and 7 for model information, including approvals.*

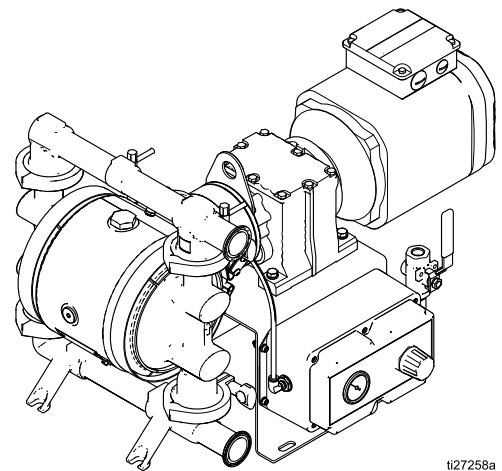

t127258a



PROVEN QUALITY. LEADING TECHNOLOGY.

# Contents









|   |    |  |    |
|---|----|--|----|
| Related Manuals .....   | 2  | Initial Configuration (AC with VFD) .....                      | 29 |
| Warnings .....  | 3  | Initial Configuration (BLDC with Graco<br>Motor Control) ..... | 29 |
| Configuration Number Matrix .....                               | 6  | Sanitize the Pump Before First Use .....                       | 29 |
| Ordering Information .....                                      | 7  | Transfer Mode Vs. Low Pulsation<br>Mode .....                  | 29 |
| Cart Systems .....  | 8  | Start and Adjust the Pump .....                                | 30 |
| Pumps With Compressors .....                                    | 9  | Flow Calibration Procedure .....                               | 30 |
| Overview .....  | 11 | Batch Calibration Procedure .....                              | 31 |
| Installation .....  | 13 | Pressure Relief Procedure .....                                | 31 |
| General Information .....                                       | 13 | Pump Shutdown .....  | 31 |
| Tips to Reduce Cavitation .....                                 | 13 | Graco Motor Control Operation (BLDC<br>Models) .....           | 32 |
| Mount the Pump .....  | 15 | Display .....  | 32 |
| Grounding .....   | 16 | Graco Motor Control Software<br>Overview .....                 | 33 |
| Air Line .....  | 18 | Operation Modes .....  | 36 |
| Fluid Supply Line .....   | 18 | Maintenance .....  | 43 |
| Fluid Outlet Line .....   | 18 | Maintenance Schedule .....                                     | 43 |
| Leak Sensor .....   | 18 | Lubrication .....  | 43 |
| Electrical Connections (AC Models) .....                        | 19 | Tighten Connections .....                                      | 43 |
| Wire Connections at the Variable<br>Frequency Drive (VFD) ..... | 19 | Clean the Graco Motor Control .....                            | 43 |
| Wire Connections at the Motor .....                             | 19 | Upgrade Graco Motor Control<br>Software .....                  | 43 |
| Wire Connections at the ATEX Motor .....                        | 20 | Flushing and Storage .....                                     | 44 |
| Wire Connections at the Explosionproof<br>Motor .....           | 20 | Troubleshooting the Graco Motor Control .....                  | 45 |
| Leak Sensor Wiring (AC Models) .....                            | 21 | Diagnostic Information .....                                   | 46 |
| Electrical Connections (BLDC Models) .....                      | 22 | Power Line Voltage Surges .....                                | 47 |
| Connect Cables .....  | 22 | Test Power Line with Multimeter .....                          | 47 |
| Wiring Tips .....   | 23 | Events .....   | 48 |
| BLDC Motor Wiring .....   | 24 | Performance Charts .....                                       | 51 |
| Controller Wiring .....   | 25 | Notes .....  | 57 |
| Leak Sensor Wiring (BLDC Models) .....                          | 26 | Dimensions .....   | 58 |
| PLC Wiring .....  | 26 | Technical Data .....   | 61 |
| Compressor Wiring .....   | 27 |  |    |
| Cart Wiring .....   | 28 |  |    |
| Operation .....   | 29 |  |    |







## Related Manuals









| Manual Number | Title  |
|---------------|--|
| 3A3168        | SaniForce 1040e Electric-Operated Diaphragm Pump, Repair/Parts |

# Warnings

The following warnings are for the setup, use, grounding, maintenance, and repair of this equipment. The exclamation point symbol alerts you to a general warning and the hazard symbols refer to procedure-specific risks. When these symbols appear in the body of this manual or on warning labels, refer back to these Warnings. Product-specific hazard symbols and warnings not covered in this section may appear throughout the body of this manual where applicable.

|  <h1 style="margin: 0;">WARNING</h1>   |  |
|---|--|
| <br>  | <p><b>ELECTRIC SHOCK HAZARD</b></p> <p>This equipment must be grounded. Improper grounding, setup, or usage of the system can cause electric shock.</p> <ul style="list-style-type: none"> <li>• Turn off and remove power before disconnecting any cables and before servicing or installing equipment. For cart-mounted models, unplug the power cord. For all other units, disconnect power at the main switch.</li> <li>• Connect only to grounded power source.</li> <li>• All electrical wiring must be done by a qualified electrician and comply with all local codes and regulations.</li> <li>• Wait five minutes for capacitor discharge before opening equipment.</li> <li>• For cart-mounted models, use only 3-wire extension cords.</li> <li>• For cart-mounted models, ensure ground prongs are intact on any power and extension cords.</li> <li>• For cart-mounted models, do not expose to rain. Store indoors.</li> <li>• Do not expose compressor box to washdown spray.</li> </ul>   |
| <br><br><br><br> | <p><b>FIRE AND EXPLOSION HAZARD</b></p> <p>Flammable fumes, such as solvent and paint fumes, in <b>work area</b> can ignite or explode. Paint or solvent flowing through the equipment can cause static sparking. To help prevent fire and explosion:</p> <ul style="list-style-type: none"> <li>• Use equipment only in well ventilated area.</li> <li>• Eliminate all ignition sources; such as pilot lights, cigarettes, portable electric lamps, and plastic drop cloths (potential static arc).</li> <li>• Ground all equipment in the work area. See <b>Grounding</b> instructions.</li> <li>• Keep work area free of debris, including solvent, rags and gasoline.</li> <li>• Do not plug or unplug power cords, or turn power or light switches on or off when flammable fumes are present.</li> <li>• Use only grounded hoses.</li> <li>• <b>Stop operation immediately</b> if static sparking occurs or you feel a shock. Do not use equipment until you identify and correct the problem.</li> <li>• Keep a working fire extinguisher in the work area.</li> </ul> <p>Static charge may build up on plastic parts during cleaning and could discharge and ignite flammable vapors. To help prevent fire and explosion:</p> <ul style="list-style-type: none"> <li>• Clean plastic parts only in well ventilated area.</li> <li>• Do not clean with a dry cloth.</li> <li>• Do not operate electrostatic guns in equipment work area.</li> </ul> |

|  <h1 style="margin: 0;">WARNING</h1>  |  |
|--|--|
| <br> | <p><b>PRESSURIZED EQUIPMENT HAZARD</b></p> <p>Fluid from the equipment, leaks, or ruptured components can splash in the eyes or on skin and cause serious injury.</p> <ul style="list-style-type: none"> <li>• Follow the <b>Pressure Relief Procedure</b> when you stop spraying/dispensing and before cleaning, checking, or servicing equipment.</li> <li>• Tighten all fluid connections before operating the equipment.</li> <li>• Check hoses, tubes, and couplings daily. Replace worn or damaged parts immediately.</li> </ul>   |
| <br> | <p><b>EQUIPMENT MISUSE HAZARD</b></p> <p>Misuse can cause death or serious injury.</p> <ul style="list-style-type: none"> <li>• Do not operate the unit when fatigued or under the influence of drugs or alcohol.</li> <li>• Do not exceed the maximum working pressure or temperature rating of the lowest rated system component. See <b>Technical Data</b> in all equipment manuals.</li> <li>• Use fluids and solvents that are compatible with equipment wetted parts. See <b>Technical Data</b> in all equipment manuals. Read fluid and solvent manufacturer's warnings. For complete information about your material, request Safety Data Sheet (SDS) from distributor or retailer.</li> <li>• Turn off all equipment and follow the <b>Pressure Relief Procedure</b> when equipment is not in use.</li> <li>• Check equipment daily. Repair or replace worn or damaged parts immediately with genuine manufacturer's replacement parts only.</li> <li>• Do not alter or modify equipment. Alterations or modifications may void agency approvals and create safety hazards.</li> <li>• Make sure all equipment is rated and approved for the environment in which you are using it.</li> <li>• Use equipment only for its intended purpose. Call your distributor for information.</li> <li>• Route hoses and cables away from traffic areas, sharp edges, moving parts, and hot surfaces.</li> <li>• Do not kink or over bend hoses or use hoses to pull equipment.</li> <li>• Keep children and animals away from work area.</li> <li>• Comply with all applicable safety regulations.</li> </ul> |
|   | <p><b>PRESSURIZED ALUMINUM PARTS HAZARD</b></p> <p>Use of fluids that are incompatible with aluminum in pressurized equipment can cause serious chemical reaction and equipment rupture. Failure to follow this warning can result in death, serious injury, or property damage.</p> <ul style="list-style-type: none"> <li>• Do not use 1,1,1-trichloroethane, methylene chloride, other halogenated hydrocarbon solvents or fluids containing such solvents.</li> <li>• Do not use chlorine bleach.</li> <li>• Many other fluids may contain chemicals that can react with aluminum. Contact your material supplier for compatibility.</li> </ul>  |

|  <h1 style="margin: 0;">WARNING</h1>   |  |
|---|--|
|    | <p><b>THERMAL EXPANSION HAZARD</b></p> <p>Fluids subjected to heat in confined spaces, including hoses, can create a rapid rise in pressure due to the thermal expansion. Over-pressurization can result in equipment rupture and serious injury.</p> <ul style="list-style-type: none"> <li>Open a valve to relieve the fluid expansion during heating.</li> <li>Replace hoses proactively at regular intervals based on your operating conditions.</li> </ul>                              |
|     | <p><b>TOXIC FLUID OR FUMES HAZARD</b></p> <p>Toxic fluids or fumes can cause serious injury or death if splashed in the eyes or on skin, inhaled, or swallowed.</p> <ul style="list-style-type: none"> <li>Read SDS to know the specific hazards of the fluids you are using.</li> <li>Store hazardous fluid in approved containers, and dispose of it according to applicable guidelines.</li> </ul>  |
|    | <p><b>BURN HAZARD</b></p> <p>Equipment surfaces and fluid that's heated can become very hot during operation. To avoid severe burns:</p> <ul style="list-style-type: none"> <li>Do not touch hot fluid or equipment.</li> </ul>  |
|    | <p><b>PERSONAL PROTECTIVE EQUIPMENT</b></p> <p>Wear appropriate protective equipment when in the work area to help prevent serious injury, including eye injury, hearing loss, inhalation of toxic fumes, and burns. This protective equipment includes but is not limited to:</p> <ul style="list-style-type: none"> <li>Protective eyewear, and hearing protection.</li> <li>Respirators, protective clothing, and gloves as recommended by the fluid and solvent manufacturer.</li> </ul> |

# Configuration Number Matrix

Check the identification plate (ID) for the Configuration Number of your pump. Use the following matrix to define the components of your pump.

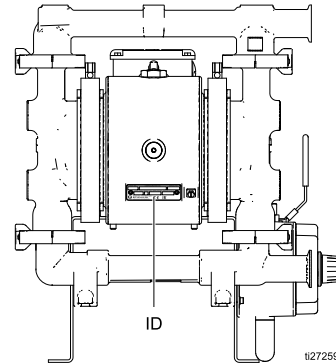

Sample Configuration Number: **1040TE-A04AS1-3SSPTPOPT**

|             |                         |          |                         |                    |                            |           |           |            |                  |
|-------------|-------------------------|----------|-------------------------|--------------------|----------------------------|-----------|-----------|------------|------------------|
| <b>1040</b> | <b>T</b>                | <b>E</b> | <b>A</b>                | <b>04A</b>         | <b>S1-3</b>                | <b>SS</b> | <b>PT</b> | <b>PO</b>  | <b>PT</b>        |
| Pump Model  | Wetted Section Material | Drive    | Center Section Material | Gear Box and Motor | Fluid Covers and Manifolds | Seats     | Balls     | Diaphragms | Manifold O-Rings |

| Pump        | Wetted Section Material |                          | Drive Type |          | Center Section Material |                 | Motor and Gearbox |  |  |
|-------------|-------------------------|--------------------------|------------|----------|-------------------------|-----------------|-------------------|--|--|
| <b>1040</b> | <b>T</b>                | Sanitary Stainless Steel | <b>E</b>   | Electric | <b>A</b>                | Aluminum        | <b>04A</b>        | Standard AC Induction Motor with Gearbox                 |  |
|             |                         |                          |            |          | <b>S</b>                | Stainless Steel | <b>04B</b>        | Brushless DC Motor                                       |  |
|             |                         |                          |            |          |                         |                 | <b>04E</b>        | NEMA 56 C Gearbox ‡                                      |  |
|             |                         |                          |            |          |                         |                 | <b>04F</b>        | IEC 90 B5 Flange Gearbox ‡                               |  |
|             |                         |                          |            |          |                         |                 | <b>05C</b>        | Brushless DC Motor (configured for cart-mounted systems) |  |

| Fluid Covers and Manifolds |                           | Seat Material |                     | Ball Material |                          | Diaphragm Material |                    | Manifold O-Rings |      |
|----------------------------|---------------------------|---------------|---------------------|---------------|--------------------------|--------------------|--------------------|------------------|------|
| <b>S1-3</b>                | Stainless steel, TriClamp | <b>SS</b>     | 316 Stainless Steel | <b>CW</b>     | Polychloroprene Weighted | <b>PO</b>          | PTFE/EPDM Overmold | <b>PT</b>        | PTFE |
| <b>S1-4</b>                | Stainless steel, DIN      |               |                     | <b>PT</b>     | PTFE                     | <b>PT</b>          | PTFE/EPDM 2-Piece  | <b>EP</b>        | EPDM |
|                            |                           |               |                     | <b>SP</b>     | Santoprene               | <b>SP</b>          | Santoprene         |                  |      |

| Approvals  |                     |
|--|---------------------|
| All Models are certified to:                                 |                     |
| Models which do not contain Santoprene*:                     |                     |
| ‡ Pumps with code <b>04E</b> or <b>04F</b> are certified to: | II 2 G ck IIB T3 Gb |

\* EC 1935/2004 compliant pumps may be subject to individual national provisions in addition to those specified in the EC regulation. It is the users responsibility to know and follow local laws.

# Ordering Information

## To Find Your Nearest Distributor

1. Visit [www.graco.com](http://www.graco.com).
2. Click on **Where to Buy** and use the **Distributor Locator**.

## To Specify the Configuration of a New Pump

Please call your distributor.

OR

Use the **Online Diaphragm Pump Selector Tool** at [www.graco.com](http://www.graco.com). Go to the **Process Equipment Page**.

## To Order Replacement Parts

Please call your distributor.

## Cart Systems

Cart systems include a stainless steel washdown cart, a BLDC motor, compressor, air control, and Graco motor controller. Two compressor input power levels are available. See table below for available systems.

| Cart System | Replacement Pump† | Pump Configuration      | Compressor kit Voltage |
|-------------|-------------------|-------------------------|------------------------|
| 25A672      | 25A879            | 1040TE-S05CS1-3SSPTPOPT | 120V                   |
| 25A703      | 25A880            | 1040TE-S05CS1-3SSPTPTPT | 120V                   |
| 25A704      | 25A881            | 1040TE-S05CS1-3SSSPSPPT | 120V                   |
| 25A705      | 25A882            | 1040TE-S05CS1-3SSCWSPEP | 120V                   |
| 25A706      | 25A879            | 1040TE-S05CS1-3SSPTPOPT | 240V                   |
| 25A707      | 25A880            | 1040TE-S05CS1-3SSPTPTPT | 240V                   |
| 25A708      | 25A881            | 1040TE-S05CS1-3SSSPSPPT | 240V                   |
| 25A709      | 25A882            | 1040TE-S05CS1-3SSCWSPEP | 240V                   |

† Pumps are replacement pumps for carted systems only. These pumps are not supplied with floor mounting brackets or air controls.

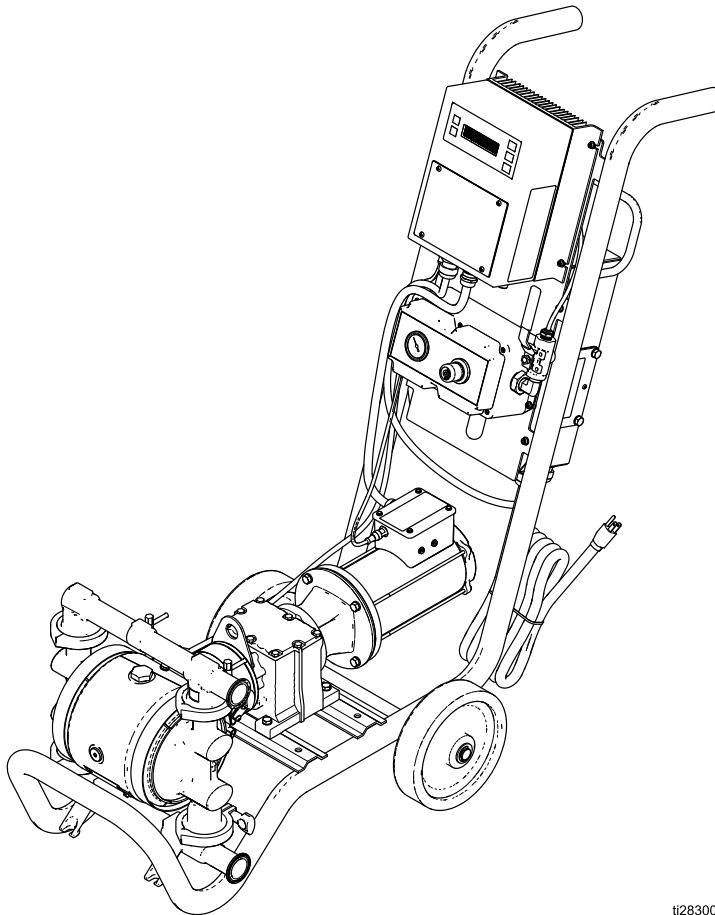

ti26300a



## Pumps With Compressors

Compressors come in either 120V or 240V configurations. A pump with a compressor contains the compressor, 25 feet of tubing, and the pump indicated in the table below.

| Pump with 120V Compressor | Pump with 240V Compressor | Pump Without Compressor |                         |
|---------------------------|---------------------------|-------------------------|-------------------------|
|                           |                           | Part Number             | Configuration           |
| 25A746                    | 25A786                    | 24Y573                  | 1040TE-A04AS1-3SSCWSPEP |
| 25A747                    | 25A788                    | 24Y574                  | 1040TE-A04AS1-3SSPTPOPT |
| 25A748                    | 25A789                    | 24Y575                  | 1040TE-A04AS1-3SSPTPTPT |
| 25A749                    | 25A790                    | 24Y576                  | 1040TE-A04AS1-3SSSPSPPT |
| 25A750                    | 25A791                    | 24Y577                  | 1040TE-A04AS1-4SSCWSPEP |
| 25A751                    | 25A792                    | 24Y579                  | 1040TE-A04AS1-3SSSPSPEP |
| 25A752                    | 25A793                    | 24Y580                  | 1040TE-A04AS1-4SSPTPOPT |
| 25A753                    | 25A794                    | 24Y581                  | 1040TE-A04AS1-4SSPTPTPT |
| 25A754                    | 25A795                    | 24Y582                  | 1040TE-A04AS1-4SSSPSPPT |
| 25A755                    | 25A796                    | 24Y583                  | 1040TE-A04AS1-4SSSPSPEP |
| 25A756                    | 25A797                    | 24Y584                  | 1040TE-A04BS1-3SSCWSPEP |
| 25A757                    | 25A798                    | 24Y585                  | 1040TE-A04BS1-3SSPTPOPT |
| 25A758                    | 25A799                    | 24Y586                  | 1040TE-A04BS1-3SSPTPTPT |
| 25A759                    | 25A801                    | 24Y587                  | 1040TE-A04BS1-3SSSPSPPT |
| 25A760                    | 25A802                    | 24Y589                  | 1040TE-A04BS1-3SSSPSPEP |
| 25A761                    | 25A803                    | 24Y590                  | 1040TE-A04BS1-4SSCWSPEP |
| 25A762                    | 25A804                    | 24Y591                  | 1040TE-A04BS1-4SSPTPOPT |
| 25A763                    | 25A805                    | 24Y592                  | 1040TE-A04BS1-4SSPTPTPT |
| 25A764                    | 25A806                    | 24Y593                  | 1040TE-A04BS1-4SSSPSPPT |
| 25A765                    | 25A807                    | 24Y594                  | 1040TE-A04BS1-4SSSPSPEP |
| 25A766                    | 25A808                    | 24Y595                  | 1040TE-S04AS1-3SSCWSPEP |
| 25A767                    | 25A809                    | 24Y596                  | 1040TE-S04AS1-3SSPTPOPT |
| 25A768                    | 25A810                    | 24Y597                  | 1040TE-S04AS1-3SSPTPTPT |
| 25A769                    | 25A811                    | 24Y598                  | 1040TE-S04AS1-3SSSPSPPT |
| 25A770                    | 25A812                    | 24Y599                  | 1040TE-S04AS1-3SSSPSPEP |
| 25A771                    | 25A813                    | 24Y600                  | 1040TE-S04AS1-4SSCWSPEP |
| 25A772                    | 25A814                    | 24Y601                  | 1040TE-S04AS1-4SSPTPOPT |
| 25A773                    | 25A815                    | 24Y602                  | 1040TE-S04AS1-4SSPTPTPT |
| 25A774                    | 25A816                    | 24Y603                  | 1040TE-S04AS1-4SSSPSPPT |
| 25A775                    | 25A817                    | 24Y604                  | 1040TE-S04AS1-4SSSPSPEP |
| 25A776                    | 25A818                    | 24Y605                  | 1040TE-S04BS1-3SSCWSPEP |
| 25A777                    | 25A819                    | 24Y606                  | 1040TE-S04BS1-3SSPTPOPT |

Ordering Information

| Pump with 120V Compressor | Pump with 240V Compressor | Pump Without Compressor |                         |
|---------------------------|---------------------------|-------------------------|-------------------------|
|                           |                           | Part Number             | Configuration           |
| 25A778                    | 25A820                    | 24Y607                  | 1040TE-S04BS1-3SSPTPTPT |
| 25A779                    | 25A821                    | 24Y608                  | 1040TE-S04BS1-3SSSPSPPT |
| 25A780                    | 25A822                    | 24Y609                  | 1040TE-S04BS1-3SSSPSPEP |
| 25A781                    | 25A823                    | 24Y610                  | 1040TE-S04BS1-4SSCWSPEP |
| 25A782                    | 25A824                    | 24Y611                  | 1040TE-S04BS1-4SSPTPOPT |
| 25A783                    | 25A825                    | 24Y613                  | 1040TE-S04BS1-4SSPTPTPT |
| 25A784                    | 25A826                    | 24Y614                  | 1040TE-S04BS1-4SSSPSPPT |
| 25A785                    | 25A827                    | 24Y615                  | 1040TE-S04BS1-4SSSPSPEP |

# Overview

The product line offers electric-powered diaphragm pumps in a wide range of models. This section shows the basic structure of available models. Fluid section options are too numerous to include. The many manifold, seat, ball, and diaphragm options are available on a wide variety of these models.

| Center Section              | Motor Type   | Controller  | Gearbox             | Compressor | Approval Options | Cart      |     |
|-----------------------------|--------------|---|---------------------|------------|------------------|-----------|-----|
| Aluminum or Stainless Steel | AC           | VFD — not included. VFD Kits 16K911 (240V) and 16K912 (480V) are available. | Yes – part of motor | Yes-120V   | None             | No*       |     |
|                             |              |   |                     | Yes-240V   | CE               | No*       |     |
|                             |              |   |                     | No†        |                  | No*       |     |
|                             | Brushless DC | Graco Motor Control – included  | NEMA                | Yes-120V   | None             | Yes       |     |
|                             |              |   |                     | Yes-240V   | CE               | Yes       |     |
|                             |              |   |                     | No†        |                  | No*       |     |
|                             | None         | None  | None                | NEMA       | None             | ATEX & CE | No* |
|                             |              |   |                     | IEC        |                  |           |     |

\* Cart Kit 24Y923 is available.

†Compressor Kits 24Y921 (120V) and 24Y922 (240V) are available

## Key Points:

- Pumps are available with an AC or Brushless DC (BLDC) motor, or with just a gearbox (for applications where a motor is already available).
- Graco recommends the use of a motor soft starter or a VFD (PN 16K911 or 16K912) in the electrical circuit for all installations. See the motor manufacturer's recommendations for proper installation when using either of these components. In all cases, make sure all products are installed in accordance with local codes and regulations.
- BLDC motors are controlled by the Graco Motor Control that is supplied with the pump.



## Material Certification

Reference: SaniForce Product Family

Issue Date: October 21, 2015

All fluid contact materials in the SaniForce product family are FDA-Compliant and meet the United States Code of Federal Regulations (CFR) Title 21, Section 177 or are of a corrosion resistant grade Stainless Steel. This includes the below product groups:

1. SaniForce 515, 1040, 1590, 2150 Air- and Electric-Operated Double Diaphragm Pumps
2. SaniForce 1590, 3150 HS Air-Operated Double Diaphragm Pumps
3. SaniForce 1590, 3150 HS 3-A Certified Air-Operated Double Diaphragm Pumps
4. SaniForce 5:1, 6:1 and 12:1 Air-Operated Piston Pumps
5. SaniForce Diaphragm Pump and Piston Pump Drum Unloaders
6. SaniForce Diaphragm Pump and Piston Pump Bin Evacuation Systems

A handwritten signature in black ink that reads 'Bradley A. Byron'.

Bradley A. Byron  
Quality Manager  
Graco Inc.

# Installation

## General Information

The Typical Installation shown is only a guide for selecting and installing system components. Contact your Graco distributor for assistance in planning a system to suit your needs. Always use Genuine Graco Parts and Accessories. Be sure all accessories are adequately sized and pressure rated to meet the system's requirements.

Reference letters in the text, for example (A), refer to the callouts in the figures located near the reference. If a callout is on a figure located elsewhere in the manual, the reference will indicate where to look within the manual.

Pumps with aluminum center sections may exhibit fading or signs of corrosion depending on cleaning solutions used.

## Tips to Reduce Cavitation

Cavitation in a double diaphragm pump is the formation and collapse of bubbles in the pumped liquid. Frequent or excessive cavitation can cause serious damage, including pitting and early wear of fluid chambers, balls, and seats. It may result in reduced efficiency of the pump. Cavitation damage and reduced efficiency both result in increased operating costs.

Cavitation depends on the vapor pressure of the pumped liquid, the system suction pressure, and the velocity pressure. It can be reduced by changing any of these factors.

1. Reduce vapor pressure: Decrease the temperature of the pumped liquid.
2. Increase suction pressure:
  - a. Lower the installed position of the pump relative to the liquid level in the supply.
  - b. Reduce the friction length of the suction piping. Remember that fittings add friction length to the piping. Reduce the number of fittings to reduce the friction length.
  - c. Increase the size of the suction piping.
  - d. Increase the Net Positive Suction Head (NPSH). See [Performance Charts, page 51](#).

**NOTE:** Be sure the inlet fluid pressure does not exceed 25% of the outlet working pressure.

3. Reduce liquid velocity: Slow the cyclic rate of the pump.

Pumped liquid viscosity is also very important but normally is controlled by factors that are process dependent and cannot be changed to reduce cavitation. Viscous liquids are more difficult to pump and more prone to cavitation.

Graco recommends taking all of the above factors into account in system design. To maintain pump efficiency, supply only enough power to the pump to achieve the required flow.

Graco distributors can supply site specific suggestions to improve pump performance and reduce operating costs.



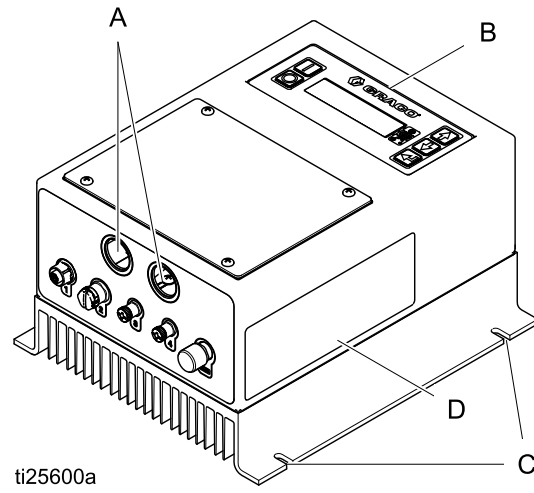

## Graco Motor Control Component Identification



**KEY:**

- A Conduit Holes
- B Display Control Panel
- C Mounting Tabs
- D Warning Label

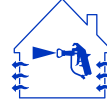
## Mount the Pump

|  |   |   |   |   |
|--|---|---|---|---|
|   |  |  |  |  |
| <p>To avoid serious injury or death from toxic fluid or fumes:</p> <ul style="list-style-type: none"> <li>• Never move or lift a pump under pressure. If dropped, the fluid section may rupture. Always follow the <a href="#">Pressure Relief Procedure, page 31</a>, before moving or lifting the pump.</li> </ul> |   |   |   |   |

|  |
|--|
| <b>NOTICE</b>  |
| <p>The pump is heavy. To prevent damage from dropping, always use 2 people or a lift to move the pump. Do not use the manifolds to lift the pump. Use at least one strap or lift ring on the pump.</p> |

1. For all mountings, be sure the pump is secured with screws through the mounting bracket on the gear box. See [Dimensions, page 58](#).

|   |
|---|
| <b>NOTICE</b>   |
| <p>To prevent pump damage, use all four fasteners to attach the bracket to the mounting location. Do not use the feet on the inlet manifold for mounting.</p> |

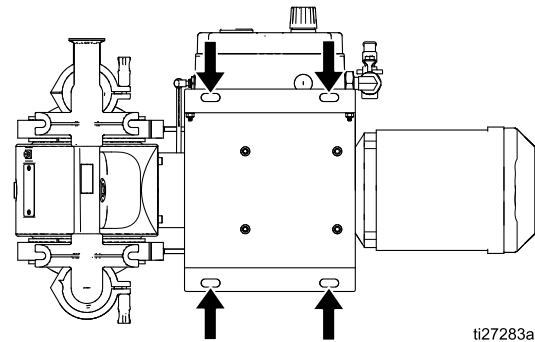





ti27283a

2. Make sure the surface is flat and that the pump doesn't wobble.
3. For BLDC models, securely mount the Graco Motor Control using the provided mounting tabs.
4. For ease of operation and service, mount the pump so fluid inlet and fluid outlet ports are easily accessible.
5. **Cart Mounting:** For all models, Cart Mounting Kit 24Y923 is available. For available pre-configured cart and pump systems, see [Cart Systems, page 8](#).

|  |
|--|
| <b>NOTICE</b>  |
| <p>To prevent unstable loading due to an offset center of gravity, lift the cart by using straps attached at multiple points on the cart rather than attempting to lift the pump and cart using only the pump lift ring.</p> |

## Grounding

|  |   |   |   |  |
|--|---|---|---|--|
|   |  |  |  |  |
| <p>The equipment must be grounded to reduce the risk of static sparking and electric shock. Electric or static sparking can cause fumes to ignite or explode. Improper grounding can cause electric shock. Grounding provides an escape wire for the electric current.</p> <ul style="list-style-type: none"> <li>• <b>Always</b> ground the entire fluid system as described below.</li> <li>• Follow your local fire codes.</li> </ul> |   |   |   |  |

Before operating the pump, ground the system as explained below.

- **Pump:** Loosen the grounding screw (R). Insert one end of a 12-gauge minimum ground wire behind the ground screw and tighten the screw securely. Connect the clamp end of the grounding wire to a true earth ground. A ground wire and clamp, Part 238909, is available from Graco.

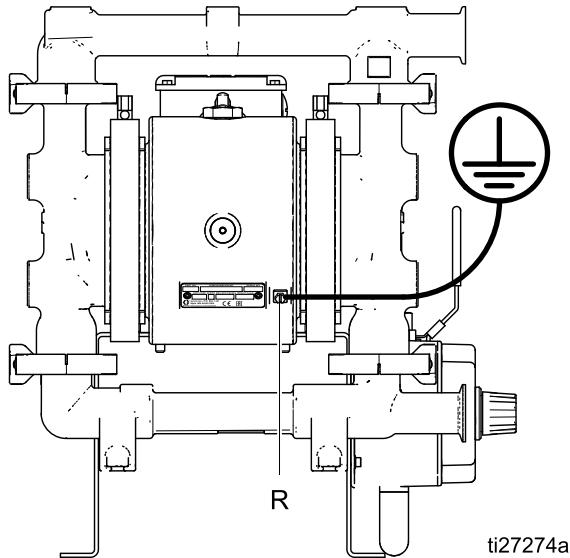

- **Motor:** AC and BLDC motors have a ground screw in the electrical box. Use it to ground the motor to the controller.
- **Air Line and Fluid hoses:** Use only grounded hoses with a maximum of 500 ft (150 m) combined hose length to ensure grounding continuity. Check electrical resistance of hoses. If total resistance to ground exceeds 29 megohms, replace hose immediately.
- **Fluid supply container:** Follow local code.
- **Solvent pails used when flushing:** Follow local code. Use only conductive metal pails, placed on a grounded surface. Do not place the pail on a nonconductive surface, such as paper or cardboard, which interrupts grounding continuity.
- **VFD:** Ground the variable frequency drive (VFD) through a proper connection to the electrical system. Refer to the VFD manual for grounding instructions.
- **Graco Motor Control:** Ground through a proper connection to a power source. See [Controller Wiring, page 25](#).

Check your system ground continuity after the initial installation, and then set up a regular schedule for checking continuity to be sure proper grounding is maintained. The resistance to earth ground should not exceed 1 ohm.



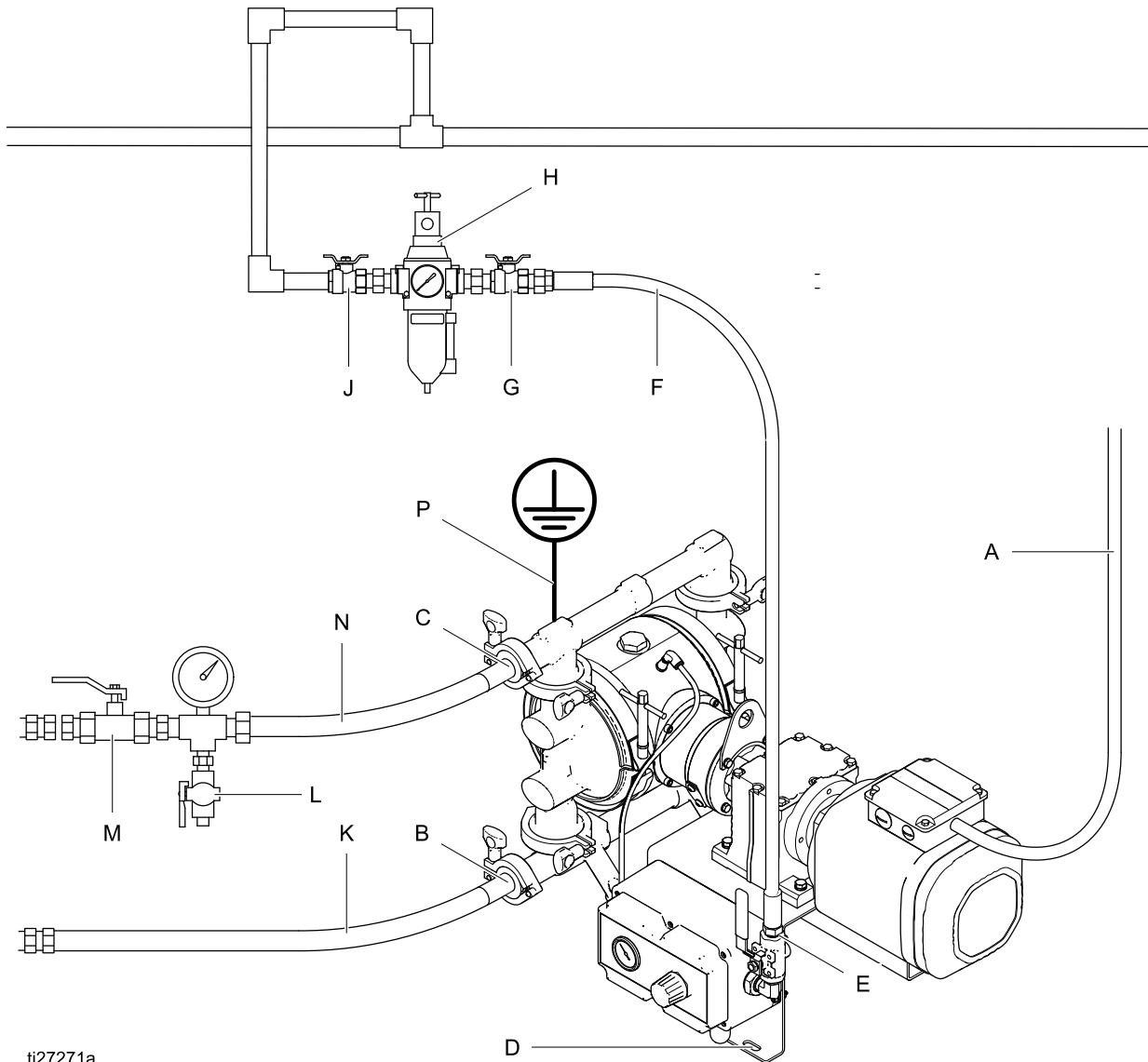

ti27271a

Figure 1 Typical Installation (AC Pump Shown)

**System Components**

- A Power cord to VFD
- B Fluid inlet port
- C Fluid outlet port
- D Mounting feet
- E Air inlet valve

**Accessories/Components Not Supplied**

- F Grounded, flexible air supply hose
- G Bleed-type master air valve
- H Air filter/regulator assembly
- J Master air valve (for accessories)
- K Grounded, flexible fluid supply hose
- L Fluid drain valve (may be required for your pump installation)
- M Fluid shutoff valve
- N Grounded, flexible fluid outlet hose
- P Ground wire and clamp (required)

## Air Line

### If using a Graco Compressor Kit:

An air line is provided in the kit which must be installed between the compressor and the pump air inlet.

### Using Your Own Compressor:

Connect the air line from the compressor to the inlet valve on the pneumatic enclosure (28).

### Using Shop Air:

NOTE: Callouts are located on Figure 1, page 17.

1. Install an air filter/regulator assembly (H). The fluid stall pressure will be the same as the setting of the air regulator. The filter removes harmful dirt and moisture from the compressed air supply.
2. Locate a bleed-type master air valve (G) close to the pump and use it to relieve trapped air. Be sure the valve is easily accessible from the pump and located downstream from the regulator.

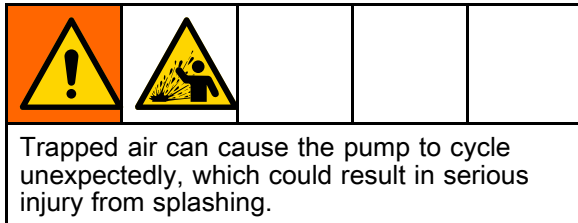

3. Locate another master air valve (J) upstream from all air line accessories and use it to isolate them during cleaning and repair.
4. Install a grounded, flexible air hose (F) between the accessories and the 3/8 npt(f) pump air inlet.

## Fluid Supply Line

1. Connect a grounded, flexible fluid hose (See K on Figure 1, page 17) to the fluid inlet port. The port is 1.5 in. (3.8 cm) sanitary flange or 40 mm DIN 11851.
2. If the inlet fluid pressure to the pump is more than 25% of the outlet working pressure, the ball check valves will not close fast enough, resulting in inefficient pump operation. Excessive inlet fluid pressure also will shorten diaphragm life. Most materials should require no more than 3 psi (0.02 MPa, 0.21 bar) fluid inlet pressure.

3. For maximum suction lift (wet and dry), see [Technical Data, page 61](#). For best results, always install the pump as close as possible to the material source. Minimize suction requirements to maximize pump performance.

## Fluid Outlet Line

NOTE: Callouts are located on Figure 1, page 17.

1. Connect a grounded, flexible fluid hose (K) to the fluid inlet port. The port is 1.5 in. (3.8 cm) sanitary flange or 40 mm DIN 11851.
2. Install a fluid drain valve (L) near the fluid outlet.
3. Install a shutoff valve (M) in the fluid outlet line.

## Leak Sensor

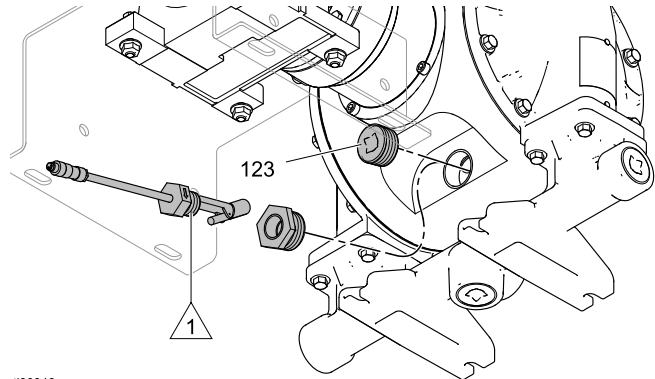

The optional leak sensor (Kit 24Y661) is highly recommended to avoid operating the pump with a ruptured diaphragm. To install the leak sensor, remove plug 123. Install the bushing and leak sensor. **NOTE:** The arrow on the leak sensor must point down. See also [Leak Sensor Wiring \(AC Models\), page 21](#), or [Leak Sensor Wiring \(BLDC Models\), page 26](#).



ti30946a

**1** To ensure a watertight seal, apply Loctite® 425 Assure™ threadlocker to threads.

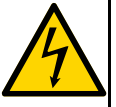
## Electrical Connections (AC Models)

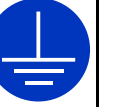
|  |   |   |   |
|--|---|---|---|
|   |  |  |  |
| <p>To avoid injury from fire, explosion, or electric shock, all electrical wiring must be done by a qualified electrician and comply with all local codes and regulations.</p> |   |   |   |

Follow the instructions in the motor manufacturer's manual. Wire size, fuse size, and other electrical devices must comply with all local codes and regulations. The motor must be wired to the VFD.

### Wire Connections at the Variable Frequency Drive (VFD)

Follow the instructions in the VFD manufacturer's manual. If you purchased an optional Graco VFD (PN 16K911 or 16K912), detailed installation and connection information is provided in the manual that ships with the VFD.

|  |
|--|
| <b>NOTICE</b>  |
| <p>To avoid equipment damage, do not plug the motor directly into a wall socket. The motor must be wired to a VFD.</p> |

### Wire Connections at the Motor

Install the wiring at the motor as follows:

1. Open the motor's electrical box.
2. Install wiring system with proper liquid-tight connections in one of the ports at the side of the motor box.
3. Connect the green ground wire to the ground screw.

4. **For 480V Wiring:** The motor comes wired for 480V. If this is the voltage you want, the existing wiring can remain as it is. Connect power wires L1 to U1, L2 to V1 and L3 to W1, as shown.

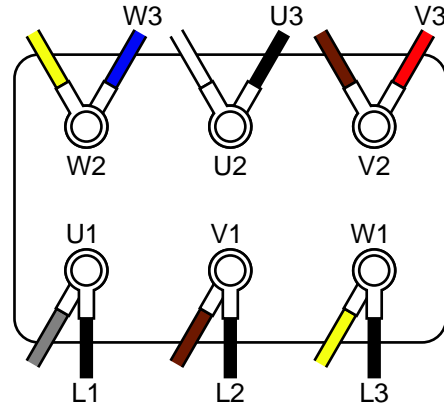

Figure 2 Connections for 480V Wiring

5. **For 240V Wiring:** Move the black wire (U3), the red wire (V3) and the blue wire (W3) as shown. Using the bridges supplied with the motor, bridge W2, U2, and V2. Then connect power wires L1 to U1, L2 to V1 and L3 to W1.

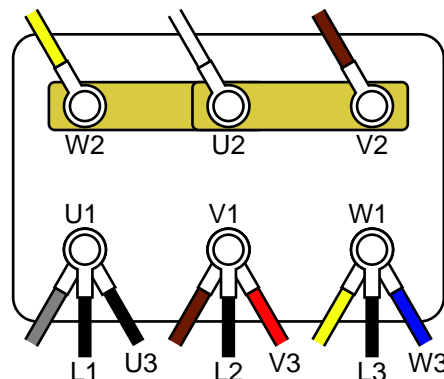

Figure 3 Connections for 240V Wiring

6. Torque terminals to 20 in-lb (2.3 N•m).
7. Close the motor electrical box. Torque the screws to 20 in-lb (2.3 N•m).

## Wire Connections at the ATEX Motor

(Optional kit 25C081)

Install the wiring at the motor as follows:

1. Open the motor's electrical box.
2. Install wiring system with proper connections to the motor electrical box.
3. Connect the green ground wire to the ground screw.
4. **For 480V Wiring:** Bridge as shown, then connect wire L1 to U1, L2 to V1, and L3 to W1.

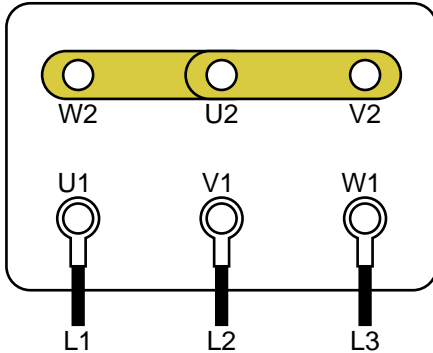

Figure 4 Connections for a 480V Wiring

5. **For 240V Wiring:** Connect wire L1 to U1, L2 to V1, and L3 to W1. Bridge as shown.

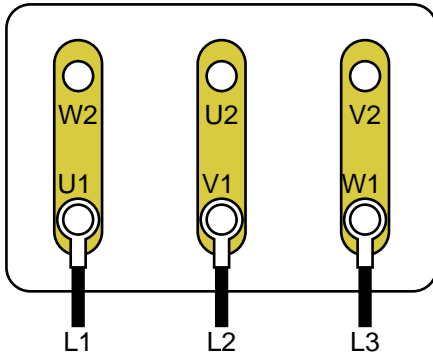

Figure 5 Connections for a 240V Wiring

6. Torque terminals to 20 in-lb (2.3 N•m).
7. Close the motor electrical box. Torque the screws to 20 in-lb (2.3 N•m).

## Wire Connections at the Explosionproof Motor

(Optional kit 25C082)

Install the wiring at the motor as follows:

1. Open the motor's electrical box.
2. Install wiring system with proper connections to the motor electrical box.
3. Connect the green ground wire to the ground screw.
4. **For 480V Wiring:** Connect wire L1 to T1, L2 to T2, and L3 to T3, and bridge the other wires, as shown.

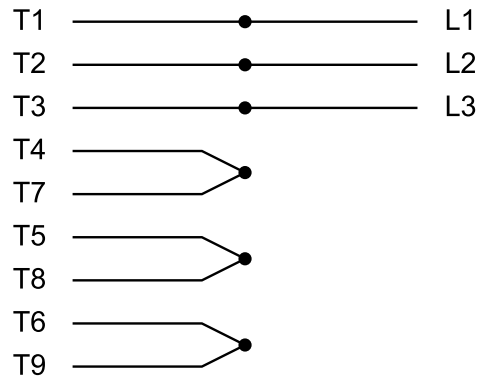

Figure 6 Connections for 480V Wiring

5. **For 240V Wiring:** Bridge the wires as shown. Then, connect L1 to T1/T7, L2 to T2/T8, and L3 to T3/T9.

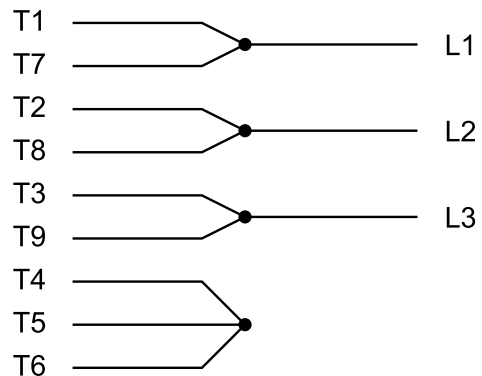

Figure 7 Connections for 240V Wiring

6. **Option:** Connect thermostat wires P1 and P2 to external overload detection. Thermostat is NC (normally closed).
7. Close the motor electrical box. Torque the screws to 20 in-lb (2.3 N•m).

## Leak Sensor Wiring (AC Models)

Follow these instructions to wire the optional Leak Sensor Kit 24Y661 to a VFD.

**NOTE:** Leak Sensor Electrical Ratings:

- Voltage: 36 VDC/30VAC
- Current: 0.5A
- Normally closed





1. Select and purchase a cable from the following table, determined by the cable routing distance between the pump and the VFD.

| Part Number | Cable Length   |
|-------------|----------------|
| 17H389      | 9.8 ft, 3.0 m  |
| 17H390      | 24.6 ft, 7.5 m |
| 17H391      | 52.5 ft, 16 m  |

2. See [Leak Sensor, page 18](#), to install the leak sensor. Connect the selected cable to the installed leak sensor.
3. Turn off power to the VFD.
4. Open the access cover on the VFD.
5. For a Graco VFD, perform the following:
  - a. Wire one lead (blue or black) to terminal 1 on the rail.
  - b. Wire a second lead (blue or black) to terminal 4 on the rail.
  - c. Connect a jumper wire between terminals 4 and 13A.

- d. Individually terminate the two remaining leads.
  - e. Close the access cover.
  - f. Turn on power to the VFD.
  - g. On the VFD display, go to screen P100.
  - h. Change the value to 4 and press the Mode button.
  - i. Go to screen P121.
  - j. Change the value to 8 and press the Mode button.
6. For a non-Graco VFD, perform the following:
    - a. Attach the blue and black leads to the detection circuit in the VFD.  
**NOTE:** Refer to the VFD manual for proper connection points.
    - b. Individually terminate the two remaining leads.
    - c. Close the access cover.
    - d. Turn on power to the VFD.
    - e. Configure the VFD to monitor the leak sensor circuit.

# Electrical Connections (BLDC Models)

|  |   |   |   |  |
|--|---|---|---|--|
|   |  |  |  |  |
| <p>To avoid injury from fire, explosion, or electric shock, all electrical wiring must be done by a qualified electrician and comply with all local codes and regulations.</p> |   |   |   |  |

## Connect Cables

The Graco Motor Control provides several connections for CAN cable and system-specific I/O devices. Connect according to the following table to ensure that the cables in your system are connected to the correct connectors on the Graco Motor Control.

**NOTE:** To maintain enclosure rating use approved Type 4 (IP66) fittings and ensure either a cable or plug is attached to all M12 and M8 connectors.

Table 1 Connector Information

| Graco Motor Control Label Identifier  | Connector Type                  | Connector Use   |
|---|---------------------------------|---|
| 1   | M12, 8-position, Female         | Motor position and temperature feedback. Connect only to Graco BLDC motor with Graco cabling. <ul style="list-style-type: none"> <li>• 121683 (9.8 ft; 3.0 m)</li> <li>• 17H349 (24.6 ft; 7.5 m)</li> <li>• 17H352 (52.5 ft; 16 m)</li> </ul> |
| 2 (Spare)   | M12, 5-position, Female, B-Code | Not currently used.   |
| 3 and 4   | M8, 4-position, Female          | See Table 2 for pinout and power specifications; must be supplied by a Class 2 power source.  |
|  | M12, 5-position, Male, A-Code   | CAN Power and Communication. Connect only to Graco supplied cabling and modules. Connect to a maximum 30 VDC, Class 2 power source.   |

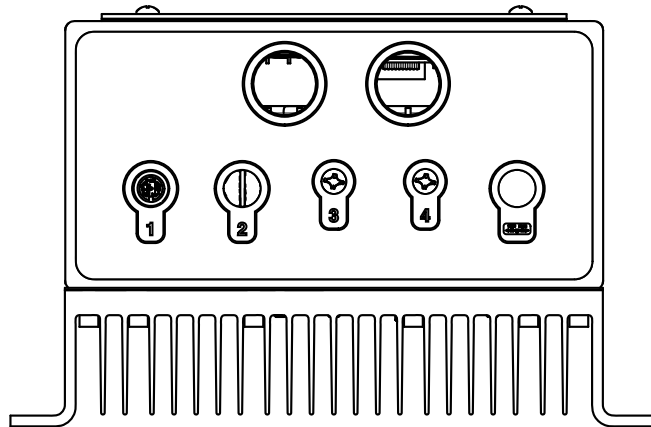

ti25593a

Table 2 Connector 3 and 4 Specifications





| Connector                       | Pin*      | Function                          | Ratings  |
|---------------------------------|-----------|-----------------------------------|--|
| 3 (Leak Sensor and Spare Input) | 1 (Brown) | 5VDC Supply                       | 5 VDC, 20 mA Max   |
|                                 | 2 (White) | Digital Input (Spare)             | Voltage Range: 5-24 VDC<br>Max Voltage: 30 VDC<br>Logic High: > 1.6 VDC<br>Logic Low: < 0.5 VDC<br>Internally Pulled-Up to 5VDC        |
|                                 | 3 (Blue)  | Common                            |  |
|                                 | 4 (Black) | Digital Input (Leak Signal)       | Voltage Range: 5-24 VDC<br>Max Voltage: 30 VDC<br>Logic High: > 1.6 VDC<br>Logic Low: < 0.5 VDC<br>Internally Pulled-Up to 5VDC        |
| 4 (PLC Control)                 | 1 (Brown) | Common                            |  |
|                                 | 2 (White) | Digital Input (Start/Stop Signal) | Voltage Range: 12-24 VDC<br>Max Voltage: 30 VDC<br>Logic High: > 6.0 VDC<br>Logic Low: < 4.0 VDC<br>Internally Pulled-Up to 12 VDC     |
|                                 | 3 (Blue)  | Common                            |  |
|                                 | 4 (Black) | Analog Input (Flow Signal)        | Input Impedance: 250 Ohms<br>Current Range: 4-20 mA<br>Max Voltage: 12.5 VDC (continuous);<br>30 VDC (momentary)<br>Max Current: 50 mA |

\* Wire colors correspond to Graco cables.

## Wiring Tips

- Use a grounded or shielded metal conduit for power cabling.
- Use the shortest possible cables or wires for incoming power.
- Use the shortest possible cables or wires between the controller and the motor.
- Route low-voltage cables away from high-power cables or wires or other known electromagnetic interference EMI sources. If cables must cross, cross at a 90° angle.
- The Graco Motor Control used with BLDC motors has an integrated line filter, so no external filter is necessary.

## BLDC Motor Wiring

|  |   |   |   |  |
|--|---|---|---|--|
|   |  |  |  |  |
| <p>To avoid injury from fire, explosion, or electric shock, all electrical wiring must be done by a qualified electrician and comply with all local codes and regulations.</p> |   |   |   |  |

See [Wiring Tips, page 23](#), for additional information on wire routing.

**NOTE:** Use only copper wire with an insulation rating of 75°C or higher.

1. Use a 1/4 in. socket to remove the cover from the motor electrical box.
2. Install wiring system with proper liquid-tight connections to the motor electrical box.

3. Connect the Graco Motor Control to the motor. Use minimum 14 AWG (2.5 mm<sup>2</sup>) wire. Use a 7 mm socket to loosen the terminal studs.
  - a. Connect M1(U) of the Graco Motor Control to U1 of the motor.
  - b. Connect M2(V) of the Graco Motor Control to V1 of the motor.
  - c. Connect M3(W) of the Graco Motor Control to W1 of the motor.
  - d. Use an 8 mm socket to loosen the ground stud. Connect the Protective Earth of the Graco Motor Control to the Protective Earth of the motor .
4. Torque to the following specifications:
  - a. Torque the M4 studs (U1, V1, and W1) to 15 in-lb (1.7 N•m).
  - b. Torque the M5 stud (Protective Earth) to 20 in-lb (2.3 N•m).
5. Connect the M12–8 Pin cable to Connector 1 on the motor.
6. Put the cover on the motor electrical box. Torque the bolts to 20 in-lb (2.3 N•m).

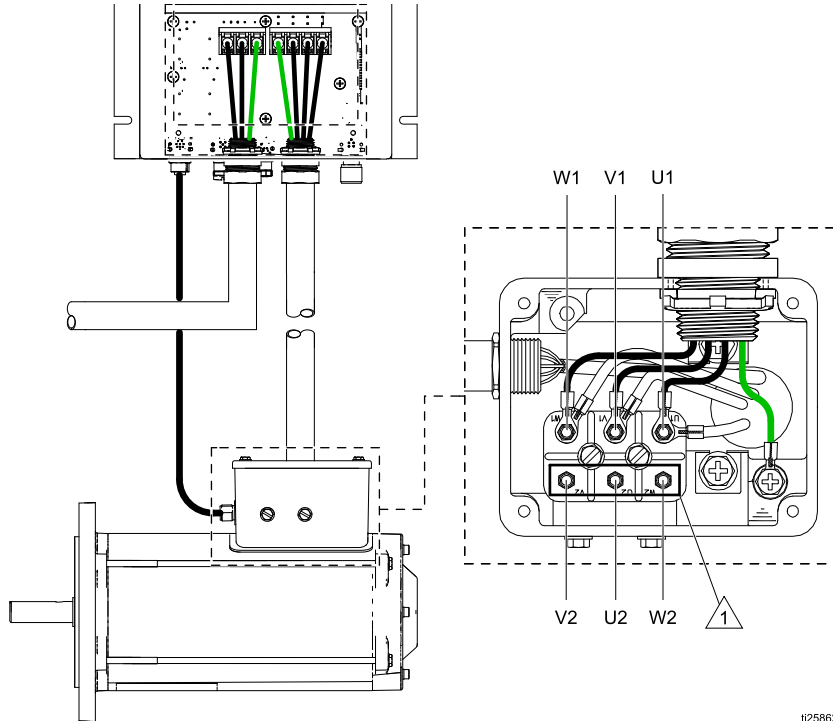







Figure 8 Wiring to Motor

 Do not use.

1125862b



## Controller Wiring

|   |   |   |   |  |
|---|---|---|---|--|
|    |  |  |  |  |
| <p>To avoid injury from fire, explosion, or electric shock, all electrical wiring must be done by a qualified electrician and comply with all local codes and regulations.</p> <ul style="list-style-type: none"> <li>• Disconnect power before servicing.</li> <li>• Wait 5 minutes for capacitor discharge before opening.</li> </ul> |   |   |   |  |

See [Wiring Tips, page 23](#), for additional information on wire routing.

- Branch circuit protection is not provided by the device. Branch circuit protection must be provided in accordance with local codes and regulations.
- This product can cause a DC current in the protective earthing conductor. Where a residual current-operated protective (RCD) or monitoring (RCM) device is used for protection in case of direct or indirect contact, only an RCD or RCM of Type B is allowed on the supply side of this product.
- Leakage Current may exceed 3.5mA AC. The minimum size of the protective earthing conductor shall comply with the local safety regulations for high protective earthing conductor current equipment.
- Use only copper wire with an insulation rating of 75°C or higher.
- Torque terminals to 20 in-lb (2.3 N•m).

1. Remove the Graco Motor Control access panel.
2. Install wiring system with proper liquid-tight connections for incoming supply power and for outgoing motor power.

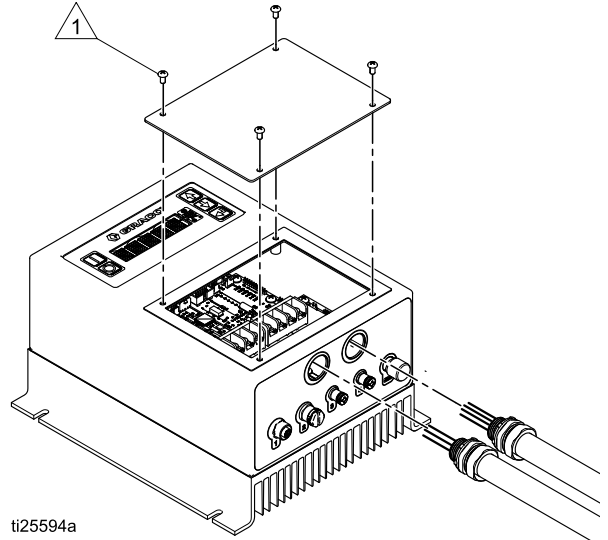

 To ensure a proper water-tight seal, torque screws to 20 in-lb (2.3 N•m).

3. Connect the Graco Motor Control to the motor. Use minimum 14 AWG (2.5 mm<sup>2</sup>) wire.
  - a. Connect M1(U) of the Graco Motor Control to U1 of the motor.
  - b. Connect M2(V) of the Graco Motor Control to V1 of the motor.
  - c. Connect M3(W) of the Graco Motor Control to W1 of the motor
  - d. Connect the Protective Earth of the Graco Motor Control to the Protective Earth of the motor .

## Electrical Connections (BLDC Models)

- Connect M12–8 Pin cable to Connector 1 on the Graco Motor Control.

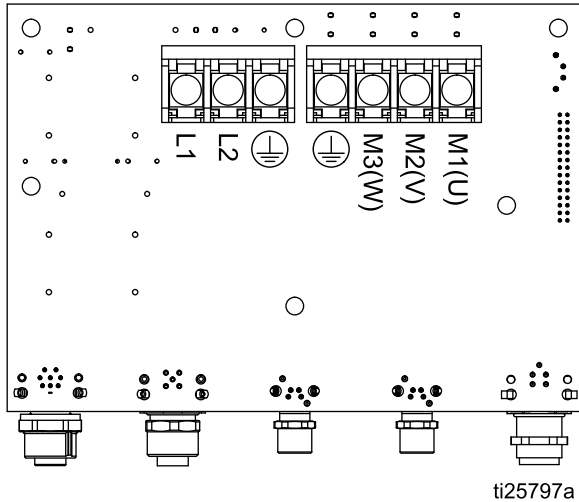

- Connect 120/240 VAC single-phase line power to L1 and L2/N. Connect supply ground to . Use minimum 12 AWG (4 mm<sup>2</sup>) wire when the system is configured for a 16A circuit and 14 AWG (2.5 mm<sup>2</sup>) when configured for a 12A circuit.

**NOTE:** If your system has a compressor, you may choose to connect power first to the compressor, then split it out to the Graco Motor Control, to share the same circuit.

- Reinstall the access panel. Torque the screws to 20 in-lb (2.3 N•m).

## Leak Sensor Wiring (BLDC Models)

**NOTE:** Leak Sensor Electrical Ratings:

- Voltage: 36 VDC/30VAC
- Current: 0.28A
- Normally closed

- Select and purchase a cable from the following table, determined by the cable routing distance between the pump and the Graco Motor Control.

| Part Number | Cable Length    |
|-------------|-----------------|
| 121683      | 9.8 ft, 3.0 m   |
| 17H349      | 24.6 ft., 7.5 m |
| 17H352      | 52.5 ft, 16 m   |

- See [Leak Sensor, page 18](#), to install the leak sensor. Connect the selected cable to the installed leak sensor.
- Connect leak sensor (with optional extension cable) to Graco Motor Control Connector 3.
- Go to Menu G206 in the Setup Screens (see [Setup Mode, page 36](#)). Set Leak Detection Type to indicate whether the system should warn that there's a leak but keep running (Deviation) or will stop the pump (Alarm).





## PLC Wiring

BLDC motors can be controlled remotely using a PLC.

**NOTE:** For “Stop Only” or “Start/Stop” control, skip steps 3, 5, and 6. See [PLC Control in Graco Motor Control Software Overview, page 33](#), for more information regarding control function. Wire colors correspond to Graco cabling.

- Connect the PLC Control cable to Graco Motor Control connector 4.
- Connect Pin 2 (Signal, white wire) and Pin 1 (Common, brown wire) to the Start/Stop signal.
- Connect Pin 4 (Signal, black wire) and Pin 3 (Common, blue wire) to the Flow signal (4–20mA).
- Set menu G209 to the desired type of external control.
- Set the desired minimum and maximum flow rates in menus G240 and G241.
- Set the analog low and high inputs in menus G212 and G213.

# Compressor Wiring

|  |   |   |   |  |
|--|---|---|---|--|
|   |  |  |  |  |
| <p>To avoid injury from fire, explosion, or electric shock, all electrical wiring must be done by a qualified electrician and comply with all local codes and regulations.</p> |   |   |   |  |

Follow these instructions to wire Graco Compressor 24Y921 (120V) or 24Y922 (240V).

See [Wiring Tips, page 23](#), for additional information on wire routing.

**NOTE:** Use only copper wire with an insulation rating of 167°F (75°C) or higher.

1. Remove the cover from the compressor's electrical box.

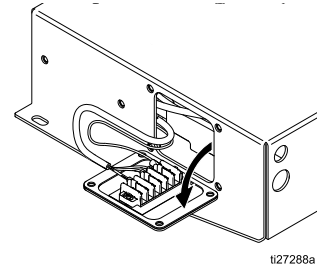
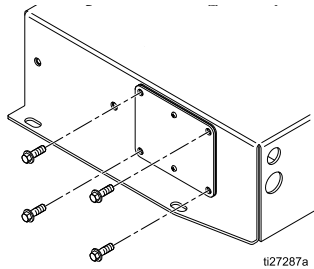

2. Install wiring system with proper connections (i.e. conduit/fittings, power cable/cable grip) to the compressor electrical box.
3. Connect line power (120VAC or 240 VAC, depending on your compressor) to L1 and L2/N.

Connect supply ground to . Use minimum 12 AWG (4 mm<sup>2</sup>) wire when the system is configured for a 16A circuit and 14 AWG (2.5 mm<sup>2</sup>) when configured for a 12A circuit. Torque terminals to 20 in-lb (2.3 N•m).

4. When powering the Graco Motor Control or VFD on the same circuit as the compressor, connect branch wiring to L1, L2/N and Ground, then connect to the Graco Motor Control or VFD. Use the same wire sizing as in Step 2.
5. Reinstall the cover of the electrical box. Torque screws to 20 in-lb (2.3 N•m).

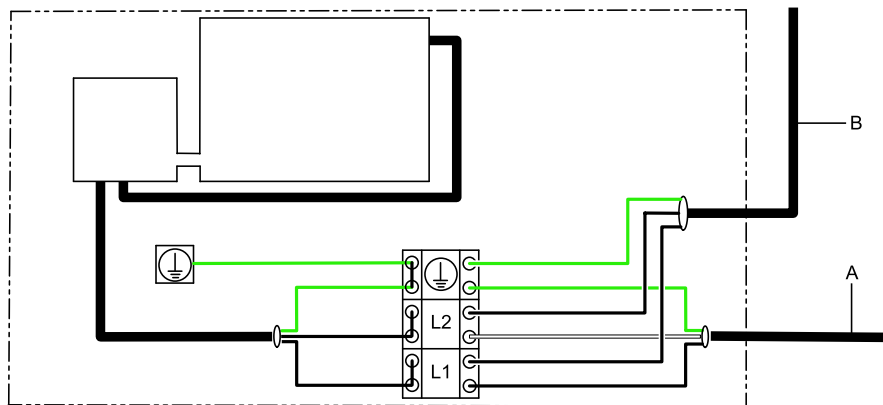

**KEY**

- A To power supply
- B To controller

Figure 9 Wire Connections at the Compressor

## Cart Wiring

|   |   |   |   |  |
|---|---|---|---|--|
|    |  |  |  |  |
| To avoid injury from fire, explosion, or electric shock, all electrical wiring must be done by a qualified electrician and comply with all local codes and regulations. |   |   |   |  |

See [Wiring Tips, page 23](#), for additional information on wire routing.

**NOTE:** Use only copper wire with an insulation rating of 75°C or higher.

**120V Cart-Mounted Models:** A power cord is supplied that can be plugged into any grounded 110V-120V wall socket.

**240V Cart-Mounted Models:** See [Compressor Wiring, page 27](#), Steps 1–3 and Step 5 to wire power to the unit.

**Cart Purchased Separately:** If you are mounting a non-cart model on a cart, wire the motor and controller according to the directions in [Electrical Connections \(AC Models\), page 19](#) or [Electrical Connections \(BLDC Models\), page 22](#). If you have a compressor, wire the compressor to the controller as shown in Figure 9 and according to [Compressor Wiring, page 27](#).

# Operation

## Initial Configuration (AC with VFD)

Configure the VFD according to the motor nameplate information.

**NOTE:** If you are using a Graco VFD (Part 16K911 or 16K912) with the Graco standard AC induction motor, use the following settings.

| Menu | Setting |
|------|---------|
| P108 | 81      |
| P171 | 163     |

## Initial Configuration (BLDC with Graco Motor Control)

For initial setup, review at least the following menus to configure the system to suit your particular needs. See the reference table in [Setup Mode, page 36](#), for detailed information about each menu option and about default settings. See also [Graco Motor Control Menu Quick Reference, page 42](#).

1. Set the desired flow units on menu G201.
2. If Batch mode is desired, set menu G200 to 1 and set the batch flow rate in menu G247.
3. Go to the Set Maintenance Interval menus (menu G230, G231, G232). Use these menus to enable the maintenance counter and set the number of cycles (in millions) for each of three maintenance intervals.
4. Go to Enable Max Power Mode (menu G204). Use this menu to indicate whether the current limit is 12A or 16A, and to enable or disable Max Power Mode (see explanation in the reference table in [Setup Mode, page 36](#)).

5. Go to Set Leak Detection Type (menu G206). Use this menu to indicate how the system should respond if a leak is detected.
6. Follow the appropriate calibration procedure and set the pump K-Factor (menu G203). Use this procedure and menu to adjust the pump displacement per cycle to match the actual performance of your pump.

## Sanitize the Pump Before First Use

It is the user's responsibility to properly sanitize the pump before first use. It is up to the user whether this will include disassembling and cleaning individual parts or simply flushing pump with a sanitizing solution. As necessary, follow the steps under [Start and Adjust the Pump, page 30](#) or under [Flushing and Storage, page 44](#).

**NOTE:** Do not expose compressor box to washdown spray.

## Transfer Mode Vs. Low Pulsation Mode

When the air pressure is at least 10 psi higher than the desired outlet pressure, the pump is in Transfer Mode and no pulsation damping is occurring. To reduce outlet pulsation, start by setting the air pressure *equal* to the desired outlet fluid pressure. Continue to adjust the air pressure relative to the outlet fluid pressure. Lower relative air pressures produce more pulsation damping. Higher relative air pressures produce better pump efficiency.

**NOTE:** Low pulsation mode may invalidate the system k-factor. See the Low Pulsation chart in [Performance Charts, page 51](#).

## Start and Adjust the Pump

1. Be sure the pump is properly grounded. See [Grounding, page 16](#).
2. Check fittings to be sure they are tight. Use a compatible liquid thread sealant on male threads. Tighten fluid inlet and fluid outlet fittings securely.
3. Place the fluid supply hose in fluid to be pumped.

**NOTE:** If fluid inlet pressure to the pump is more than 25% of outlet working pressure, the ball check valves will not close fast enough, resulting in inefficient pump operation.

### NOTICE

Excessive fluid inlet pressure can reduce diaphragm life.

4. Place the end of the fluid hose into an appropriate container.
5. Close the fluid drain valve.
6. Turn the air regulator knob to match the desired fluid stall pressure. Open all bleed-type master air valves.
7. If the fluid hose has a dispensing device, hold it open. Be sure all fluid shutoff valves are open.
8. **VFD:** Set the desired frequency.  
**Graco Motor Control in Flow Mode:** Set flow rate.  
**Graco Motor Control in Batch Mode:** Set volume.
9. Press the start (run) button on the Graco Motor Control or on the VFD.
10. If you are flushing, run the pump long enough to thoroughly clean the pump and hoses.

## Flow Calibration Procedure

**NOTE:** This procedure applies to systems using the Graco Motor Control. If you are using a VFD, follow the instructions in that user manual.

1. The system is in Flow Control Mode. Menu G200 = 0.
2. The pump is primed. See [Start and Adjust the Pump, page 30](#).
3. Set the desired flow rate from the Run Mode screen.
4. Go to the View or Reset Volume menu (G101).
5. Press and hold  to clear the volume total.
6. With a container ready to catch the dispensed material, start the pump.
7. Run the pump for the desired calibration time. Note that a large volume is more accurate, at least 10 or more cycles.
8. Stop the pump.
9. Record the volume ( $V_{\text{batch}}$ ) shown on the G101 menu.
10. Measure the volume ( $V_{\text{actual}}$ ) that was actually captured during the dispense. Be sure to measure in the same units being displayed. See Set Flow Units (menu G201) to change units.
11. See Set the Pump K-Factor (menu G203). Write down the K-factor currently displayed ( $K\text{-Factor}_{\text{old}}$ ).
12. Calculate the new K-Factor using the following formula:  

$$K\text{-Factor}_{\text{new}} = K\text{-Factor}_{\text{old}} \times (V_{\text{actual}} / V_{\text{batch}})$$
13. Set the G203 menu to  $K\text{-Factor}_{\text{new}}$ .

## Batch Calibration Procedure

**NOTE:** This procedure applies to systems using the Graco Motor Control. If you are using a VFD, follow the instructions in that user manual.

1. The system is in Batch Control Mode. Menu G200 = 1.
2. The pump is primed. See [Start and Adjust the Pump, page 30](#).
3. Set the desired batch flow rate on the Batch Mode Target Flow menu G247.
4. Set the desired batch volume ( $V_{batch}$ ) on the Run Mode screen. Note that a large volume is more accurate, at least 10 or more cycles. See Set Flow Units (menu G201) to change units.
5. With a container ready to catch the dispensed material, start the pump.
6. The pump will run for the set batch volume.
7. After the pump has stopped, measure the volume ( $V_{actual}$ ) that was actually captured during the dispense. Be sure to measure in the same units as the batch setpoint.
8. See Set the Pump K-Factor (menu G203). Write down the K-factor currently displayed ( $K\text{-Factor}_{old}$ ).
9. Calculate the new K-Factor using the following formula:  

$$K\text{-Factor}_{new} = K\text{-Factor}_{old} \times (V_{actual} / V_{batch})$$
10. Set the G203 menu to  $K\text{-Factor}_{new}$ .

## Pressure Relief Procedure



Follow the Pressure Relief Procedure whenever you see this symbol.

|   |  |  |  |  |
|---|--|--|--|--|
|   |  |  |  |  |
| <p>This equipment stays pressurized until pressure is relieved manually. To help prevent serious injury from pressurized fluid, such as splashing in the eyes or on skin, follow the Pressure Relief Procedure when you stop pumping and before you clean, check, or service the equipment.</p> |  |  |  |  |

1. Remove power from the system.
2. Open the dispensing valve, if used.
3. Open the fluid drain valve (L) to relieve fluid pressure. Have a container ready to catch the drainage.
4. Close the pump air inlet valve on the pneumatic enclosure.
5. **Units with a compressor:** Cycle the valve to bleed any remaining air.

## Pump Shutdown

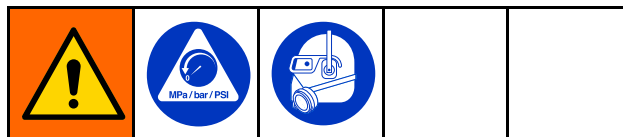

At the end of the work shift and before you check, adjust, clean, or repair the system, follow the [Pressure Relief Procedure, page 31](#).

# Graco Motor Control Operation (BLDC Models)

## Display





The Graco Motor Control provides the interface for users to enter selections and view information related to setup and operation.

Membrane keys are used to input numerical data, enter the setup screens, and select or input setup values.

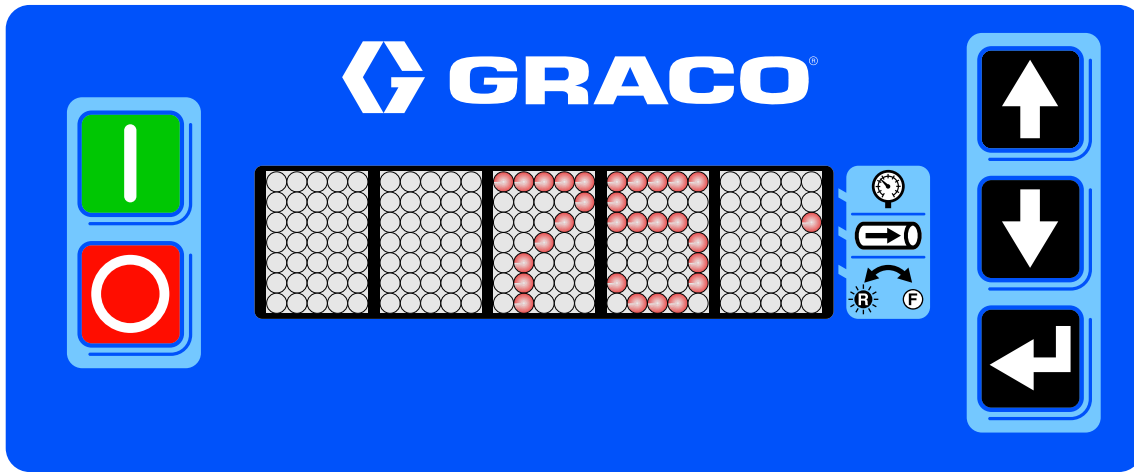
**NOTICE**

To prevent damage to the softkey buttons, do not press the buttons with sharp objects such as pens, plastic cards, or fingernails.



| Membrane Key   | Action  |
|--|---|
|   | <p><b>Manual Control:</b> Press to start the pump.</p> <p><b>Remote Control (PLC):</b> Press to clear alarm EBGO. The remote signal will then start the pump again.</p>   |
|   | <p><b>Manual Control:</b> Press to stop the pump. If this button is pressed a second time (while the pump is decelerating), the pump will stop immediately.</p> <p><b>Remote Control (PLC):</b> The remote signal normally stops the pump. Press to override the remote control and set the EBGO alarm.</p>   |
| <br> | <p>Press to navigate the setup menu codes, to adjust the digits in a numerical entry, or to scroll to the desired setpoint.</p>   |
|   | <p>Function varies by mode and current activity.</p> <ul style="list-style-type: none"> <li>• <b>Run Mode:</b> Press to edit the setpoint. Press again to accept the entry. Also press to acknowledge an event code. When not editing, press and hold for 2 seconds to enter Setup Mode</li> <li>• <b>Setup Mode:</b> Press to enter a selection or to accept the current value of an entry. When not editing, press and hold for 2 seconds to return to Run Mode.</li> </ul> |



## Graco Motor Control Software Overview

The Graco Motor Control has two possible control methods: Flow Control and Batch Dispense. See



Table 3 for an explanation of each method. Table 4 explains some key Graco Motor Control features.

**Table 3 Control Methods**

| Control Method | Details  |
|----------------|--|
| Flow Control   | <ul style="list-style-type: none"> <li>• Controls the pump flow by increasing or decreasing the speed of the motor.</li> <li>• Shows the current pump flow in user selectable units.</li> <li>• Maximum acceleration and deceleration are limited by user setting.</li> </ul>  |
| Batch Dispense | <ul style="list-style-type: none"> <li>• Dispenses a user specified amount of material.                             <ul style="list-style-type: none"> <li>– Shows the volume remaining to be dispensed in user selectable units.</li> <li>– Dispensing can be interrupted and resumed if the dispense amount is not changed.</li> </ul> </li> <li>• Dispense flow rate is specified by the user.</li> <li>• Pump K-Factor is calibrated by external means and specified in user settings.</li> <li>• Maximum acceleration and deceleration is limited by user setting.</li> </ul> |

**Table 4 Graco Motor Control Key Features**

| Control Feature | Details   |
|-----------------|---|
| Leak Detection  | <ul style="list-style-type: none"> <li>• Receives a signal from the pump leak detector informing the controller of a hose rupture.</li> <li>• The controller either warns or stops the pump, depending on a user setting.</li> <li>• An event code is displayed.</li> </ul> |
| Cycle Counting  | <ul style="list-style-type: none"> <li>• The controller tracks pump cycles and informs the user of any scheduled maintenance intervals.</li> <li>• User selects the number of cycles for the maintenance interval (i.e. hose replacement).</li> </ul>                       |
| Batch Counter   | <ul style="list-style-type: none"> <li>• The controller tracks the dispensed pump volume.                             <ul style="list-style-type: none"> <li>– The counter can be reset by the user.</li> </ul> </li> </ul>   |

| Control Feature | Details   |
|-----------------|---|
| PLC Control     | <ul style="list-style-type: none"> <li>• Input Hardware:               <ul style="list-style-type: none"> <li>– Digital Input (Start/Stop) — Sinking                   <ul style="list-style-type: none"> <li>◆ 12VDC (internally pulled-up) logic</li> <li>◆ Logic Low (asserted/closed) &lt; 4VDC</li> <li>◆ Logic High (released/open) &gt; 6VDC</li> <li>◆ 35VDC tolerant</li> </ul> </li> <li>– Analog Input (Flow Signal)                   <ul style="list-style-type: none"> <li>◆ 4-20 mA logic</li> <li>◆ 250 ohm impedance</li> <li>◆ 35VDC (2W) tolerant</li> </ul> </li> </ul> </li> <li>• Stop Only (Manual Start)               <ul style="list-style-type: none"> <li>– Start/Stop signal must be asserted (pulled low) to run the pump.</li> <li>– The user manually starts the system.</li> <li>– The stop button or Start/Stop signal will stop the pump.</li> </ul> </li> <li>• Start/Stop (Full Remote)               <ul style="list-style-type: none"> <li>– The falling edge of the Start/Stop signal will start the pump. The Start/Stop signal must remain asserted (pulled low) to run the pump.</li> <li>– Pressing the local Stop button disables the system until the local Start button is pressed.</li> </ul> </li> <li>• Full Control (Both Start/Stop and Flow)               <ul style="list-style-type: none"> <li>– The falling edge of the Start/Stop signal will start the pump. The Start/Stop signal must remain asserted (pulled low) to run the pump.</li> <li>– Pressing the local Stop button disables the system until the local Start button is pressed.</li> <li>– Analog input is used for pump flow.</li> <li>– Input range can be configured in user settings (see menus G212, G213, G240, and G241)</li> <li>– Analog Control Mode:                   <ul style="list-style-type: none"> <li>◆ Flow Control: Target Flow Rate</li> <li>◆ Batch Dispense: Dispense Flow Rate</li> </ul> </li> </ul> </li> <li>• Override Stop: When operating in Start/Stop Control or Full Control,  can be used to override the external signal and stop the pump. This override will cause the EBGO event to be set. Press  to acknowledge all events. Then press  to clear the EBGO event and re-enable external control. The controller will then look for a falling signal edge to signal a Start.</li> </ul> |





| Control Feature | Details  |
|-----------------|--|
| Max Power Mode  | <ul style="list-style-type: none"> <li>• This mode allows the user to disable the over current and motor temperature faults. The result is a reduction in pump performance that is dependent on the limiting factor.</li> <li>• The system alerts the user that the pump is running at reduced performance.</li> <li>• Current (Power) Scaling                             <ul style="list-style-type: none"> <li>– The Graco Motor Control limits power to the motor depending on the voltage and current available from line power.</li> <li>– 12/16A selectable in software (factory set is 12A)</li> </ul> </li> <li>• Motor Temperature Scaling                             <ul style="list-style-type: none"> <li>– The Graco Motor Control limits power to the motor when the motor winding temperature is too hot.                                     <ul style="list-style-type: none"> <li>◆ Limit Start – 120°C</li> <li>◆ Limit Stop (Full Shutdown) – 150°C</li> </ul> </li> </ul> </li> </ul> |

## Operation Modes

The Graco Motor Control has two operation modes: Run Mode and Setup Mode.



### Run Mode

When in Run Mode, the Graco Motor Control displays the current operating point (flow rate or volume remaining).

To adjust the setpoint, press . Use  and  to scroll to the desired value. Press  to accept your entry.

If your system is using External Full Control (menu G209 is set to 3), the setpoint is externally controlled. The setpoint may be viewed, but it cannot be adjusted.





### Setup Mode

Press  for 2 seconds to enter Setup Mode. If a password has been set, enter it to proceed. The Setup Mode screens timeout (return to the Run Screen) after 60 seconds without a button press. Each menu in Setup times out after 30 seconds unless the user presses .



The Setup Mode is organized into four broad categories:

- 100s: Maintenance
- 200s: Setup
- 300s: Diagnostics
- 400s: Advanced

The reference table provides a description of each Setup Mode menu option.

1. Use  and  to scroll to the desired setup menu code.
2. Press  to make an entry or selection for that code. For example, scroll to setup menu code G210, which is used to set a password. Press .

Some Setup Mode menus require the user to enter a number.

1. Use  and  to set each digit of the number.
2. Press  on the last digit to return to the setup menu code options.

Other Setup Menu options require the user to scroll through and select the number that corresponds to the desired selection. The table shows the content that corresponds to each scrolled number in a menu.











- Use  and  to scroll to the desired number.
- Press  on the selected number. For example, in menu G206, scroll to the number 2 and press  if you want your system to issue an alarm and stop the pump if it detects a leak.

Table 5 Available Menus with Descriptions

| <b>Run Mode</b>            |   |
|----------------------------|---|
| Flow Control               | <p>Displays pump flow. Units are user selectable. See Set Flow Units (menu G201).</p> <ul style="list-style-type: none"> <li>• Scroll to the desired number to reset the target.</li> <li>• Range is 0 — 280 cpm.</li> </ul>  |
| Batch Dispense             | <p>Displays the remaining batch volume. Units are user selectable. See Set Flow Units (menu G201). Dispense volume can be edited only when the pump is stopped. Volume will reset upon completion, or when changed by the user. Stopping and starting the pump does not reset the batch volume.</p> <ul style="list-style-type: none"> <li>• Scroll to the desired number to reset the target.</li> <li>• Range is 0 — 9999 cycles</li> </ul> |
| <b>Setup Mode</b>          |   |
| <b>G100</b>                | <p>Displays the last 20 system event codes. Use  and  to scroll though the event codes</p>  |
| VIEW EVENTS                |   |
| <b>G101</b>                | <p>Displays the batch volume that has been dispensed.</p> <ul style="list-style-type: none"> <li>• Hold  for 2 seconds to reset the counter.</li> <li>• Batch counter automatically resets at 99999 cycles, liters, or gallons.</li> <li>• Units are user selectable. See Set Flow Units (menu G201).</li> </ul>   |
| VIEW or RESET BATCH VOLUME |   |
| <b>G102</b>                | <p>Displays the total number of pump cycles for the life of the pump.</p> <ul style="list-style-type: none"> <li>• User cannot reset.</li> <li>• Displays in cycles, thousands of cycles, or millions of cycles.</li> </ul>   |
| VIEW LIFE TOTAL            |   |
| <b>G130</b>                | <p>Displays the number of pump cycles since the last maintenance.</p> <ul style="list-style-type: none"> <li>• Hold  for 2 seconds to reset the counter.</li> <li>• Displays in cycles, thousands of cycles, or millions of cycles.</li> </ul>   |
| VIEW MAINTENANCE COUNTER 1 |   |
| <b>G131</b>                | <p>Displays the number of pump cycles since the last maintenance.</p> <ul style="list-style-type: none"> <li>• Hold  for 2 seconds to reset the counter.</li> <li>• Displays in cycles, thousands of cycles, or millions of cycles.</li> </ul>   |
| VIEW MAINTENANCE COUNTER 2 |   |
| <b>G132</b>                | <p>Displays the number of pump cycles since the last maintenance.</p> <ul style="list-style-type: none"> <li>• Hold  for 2 seconds to reset the counter.</li> <li>• Displays in cycles, thousands of cycles, or millions of cycles.</li> </ul>   |
| VIEW MAINTENANCE COUNTER 3 |   |
| <b>G200</b>                | <p>Set the pump control mode. The pump must be stopped to edit this field.<br/>0 = Flow Control (default)<br/>1 = Batch Control</p>   |
| SET CONTROL MODE           |   |
| <b>G201</b>                | <p>Set the display flow units, which also sets the internal volume units.<br/>0 = cycles per minute (cpm, default)<br/>1 = gallons per minute (gpm)<br/>2 = liters per minute (lpm)</p>   |
| SET FLOW UNITS             |   |

|             |                            |  |
|-------------|----------------------------|--|
| <b>G203</b> | SET PUMP K-FACTOR          | Set the pump displacement per cycle. Follow the <a href="#">Flow Calibration Procedure, page 30</a> , or the <a href="#">Batch Calibration Procedure, page 31</a> , to obtain the information needed for this menu. Units are always cc/cycle. The menu is visible only if flow units (menu G201) are set to gpm (1) or lpm (2), <b>not cpm (0)</b> . The pump must be stopped to edit this field. |
|             |                            | <ul style="list-style-type: none"> <li>• Range is 262–785 cc/cycle.</li> <li>• Default: is 523 cc/cycle.</li> </ul>  |
| <b>G204</b> | ENABLE MAX POWER MODE      | Enable this setting to change the Over Current and Motor Temperature events from Alarms to Deviations, which allows the pump to keep running in the error state. See Events for an explanation of the different types of errors. Performance will be reduced (may not maintain flow setpoint). The pump must be stopped to edit this field.  |
|             |                            | <ul style="list-style-type: none"> <li>0 = Disabled – 12A (Default)</li> <li>1 = Disabled – 16A</li> <li>2 = Enabled – 12A</li> <li>3 = Enabled – 16A</li> </ul>   |
| <b>G206</b> | SET LEAK DETECTION TYPE    | Set the desired system response to a leak detection.   |
|             |                            | <ul style="list-style-type: none"> <li>0 = Disabled (Default)</li> <li>1 = Deviation (system alerts the user but does not stop the pump)</li> <li>2 = Alarm (system alerts the user and stops the pump).</li> </ul>  |
| <b>G207</b> | SET MAXIMUM ACCELERATION   | Set the time in seconds to maximum speed (280 cpm) from stop.  |
|             |                            | <ul style="list-style-type: none"> <li>• Range is 1-300 seconds.</li> <li>• Default is 20 seconds.</li> </ul>  |
| <b>G208</b> | SET MAXIMUM DECELERATION   | Set the time in seconds to stop from the maximum speed (280 cpm).  |
|             |                            | <ul style="list-style-type: none"> <li>• Range is 1-300 seconds.</li> <li>• Default is 1 second.</li> </ul>  |
| <b>G209</b> | CONFIGURE EXTERNAL CONTROL | Configure the external control inputs. The pump must be stopped to edit this field.  |
|             |                            | <ul style="list-style-type: none"> <li>0 = Disabled (Default)</li> <li>1 = Stop Only (Manual Start)</li> <li>2 = Start/Stop (Full Remote)</li> <li>3 = Full Control (Both Start/Stop and Flow)</li> </ul>  |
| <b>G210</b> | SET or DISABLE PASSWORD    | Set the setup lockout password. Users who do not know the password will be able to change information in the G100s (Maintenance) and G300s (Diagnostics), but will be locked out from the G200s (Setup) and G400s (Advanced).  |
|             |                            | <ul style="list-style-type: none"> <li>• Range is 1-99999.</li> <li>• Enter 0 to disable the password.</li> <li>• Enter 99999 to reveal the Advanced menu (menu G400).</li> <li>• Default is 0.</li> </ul>   |
| <b>G212</b> | SET 4–20 ANALOG LOW INPUT  | Set the analog input level that corresponds to the minimum allowable control setpoint (menus G240 or G245). This menu is visible only if external controls (menu G209) are configured for full control (3).  |
|             |                            | <ul style="list-style-type: none"> <li>• Range is 4.0 – 20.0 mA.</li> <li>• Default is 4.0 mA.</li> </ul>  |

|                            |   |
|----------------------------|---|
| <b>G213</b>                | Set the analog input level that corresponds to the maximum allowable control setpoint (menus G241 or G246). This menu is visible only if external controls (menu G209) are configured for full control (3).   |
| SET 4–20 ANALOG HIGH INPUT | <ul style="list-style-type: none"> <li>• Range is 4.0 – 20.0 mA.</li> <li>• Default is 20 mA.</li> </ul>  |
| <b>G230</b>                | Set the desired maintenance interval in millions of cycles.   |
| SET MAINTENANCE INTERVAL 1 | <ul style="list-style-type: none"> <li>• Range is 0.1 — 99.9 million cycles.</li> <li>• Enter 0 to disable the maintenance counter.</li> <li>• Default is 0.</li> </ul>   |
| <b>G231</b>                | Set the desired maintenance interval in millions of cycles.   |
| SET MAINTENANCE INTERVAL 2 | <ul style="list-style-type: none"> <li>• Range is 0.1 — 99.9 million cycles.</li> <li>• Enter 0 to disable the maintenance counter.</li> <li>• Default is 0.</li> </ul>   |
| <b>G232</b>                | Set the desired maintenance interval in millions of cycles.   |
| SET MAINTENANCE INTERVAL 3 | <ul style="list-style-type: none"> <li>• Range is 0.1 — 99.9 million cycles.</li> <li>• Enter 0 to disable the maintenance counter.</li> <li>• Default is 0.</li> </ul>   |
| <b>G240</b>                | Set the lowest selectable flow setpoint.  |
| SET MINIMUM FLOW SETPOINT  | <ul style="list-style-type: none"> <li>• Units are user selectable. See Set Flow Units (menu G201).</li> <li>• Menu is visible only if Control Mode (menu G200) is set to flow (0) or if External Control (menu G209) is set to full control (3).</li> <li>• Range is 0–280 cycles per minute.</li> <li>• Default is 0.</li> </ul> <p>Example: If you want the system to dispense at least 5 lpm, set the control mode to flow control (menu G200), and the flow units to liters (menu G201). Set this menu to 5. Users will not be able to enter a minimum setpoint lower than 5 lpm.</p>              |
| <b>G241</b>                | Set the highest selectable flow setpoint.   |
| SET MAXIMUM FLOW SETPOINT  | <ul style="list-style-type: none"> <li>• Units are user selectable. See Set Flow Units (menu G201).</li> <li>• Menu is visible only if Control Mode (menu G200) is set to flow (0) or if External Control (menu G209) is set to full control (3).</li> <li>• Range is 0–280 cycles per minute.</li> <li>• Default is 280.</li> </ul> <p>Example: If you want the system to dispense no more than 10 lpm, set the control mode to flow control (menu G200) and set the flow units to liters (menu G201). Set this menu to 10. Users will not be able to enter a maximum setpoint higher than 10 lpm.</p> |

|                             |   |
|-----------------------------|---|
| <b>G245</b>                 | Set the lowest selectable volume setpoint.  |
| SET MINIMUM VOLUME SETPOINT | <ul style="list-style-type: none"> <li>• Units are user selectable. See Set Flow Units (menu G201).</li> <li>• Menu is visible only if Control Mode (menu G200) is set to batch (1).</li> <li>• Range is 0–9999 cycles.</li> <li>• Default is 0.</li> </ul> <p>Example: If you want the system to dispense at least 15 gallons in each batch, set the control mode to batch control (menu G200) and set the flow units to gallons (menu G201). Set this menu to 15. Users will not be able to enter a minimum setpoint lower than 15 gallons.</p>         |
| <b>G246</b>                 | Set the highest selectable volume setpoint.   |
| SET MAXIMUM VOLUME SETPOINT | <ul style="list-style-type: none"> <li>• Units are user selectable. See Set Flow Units (menu G201).</li> <li>• Menu is visible only if Control Mode (menu G200) is set to batch (1).</li> <li>• Range is 0–9999 cycles.</li> <li>• Default is 9999.</li> </ul> <p>Example: If you want the system to dispense no more than 50 gallons in each batch, set the control mode to batch control (menu G200) and set the flow units to gallons (menu G201). Set this menu to 50. Users will not be able to enter a maximum setpoint higher than 50 gallons.</p> |
| <b>G247</b>                 | Set the flow rate to use while in batch control mode.   |
| BATCH MODE TARGET FLOW      | <ul style="list-style-type: none"> <li>• Units are user selectable. See Set Flow Units (menu G201).</li> <li>• Menu is visible only if Control Mode (menu G200) is set to batch (1).</li> <li>• This menu <i>is not</i> editable if external controls (menu G209) are configured for full control (3). The system displays the setpoint as set by the analog input.</li> <li>• Range is 0–280 cycles per minute.</li> <li>• Default is 0.</li> </ul>  |
| <b>G300</b>                 | Display the pump flow rate  |
| VIEW FLOW RATE              | <ul style="list-style-type: none"> <li>• User cannot edit.</li> <li>• Units are user selectable. See Set Flow Units (menu G201).</li> </ul>   |
| <b>G302</b>                 | Displays the BUS voltage in V.  |
| VIEW BUS VOLTAGE            | <ul style="list-style-type: none"> <li>• User cannot edit.</li> </ul>   |
| <b>G303</b>                 | Displays the RMS motor voltage in V.  |
| VIEW MOTOR VOLTAGE          | <ul style="list-style-type: none"> <li>• User cannot edit.</li> </ul>   |
| <b>G304</b>                 | Displays the RMS motor current in A.  |
| VIEW MOTOR CURRENT          | <ul style="list-style-type: none"> <li>• User cannot edit.</li> </ul>   |
| <b>G305</b>                 | Displays the motor power in W.  |
| VIEW MOTOR POWER            | <ul style="list-style-type: none"> <li>• User cannot edit.</li> </ul>   |
| <b>G306</b>                 | Displays the IGBT temperature in °C.  |
| VIEW CONTROLLER TEMPERATURE | <ul style="list-style-type: none"> <li>• User cannot edit.</li> </ul>   |







|                                       |  |
|---------------------------------------|--|
| <b>G307</b>                           | Displays the motor temperature in °C.  |
| VIEW MOTOR TEMPERATURE                | <ul style="list-style-type: none"> <li>• User cannot edit.</li> </ul>  |
| <b>G308</b>                           | Displays the software configuration.   |
| VIEW SOFTWARE VERSION & SERIAL NUMBER | <ul style="list-style-type: none"> <li>• User cannot edit.</li> <li>• Information displayed includes software part number, software version, and serial number.</li> </ul>   |
| <b>G309</b>                           | Displays the leak sensor input status.   |
| VIEW LEAK SENSOR INPUT                | <ul style="list-style-type: none"> <li>• User cannot edit.</li> <li>• 0 = No Leak Detected</li> <li>• 1 = Leak Detected</li> </ul>   |
| <b>G310</b>                           | Displays the run/stop input status.  |
| VIEW RUN/STOP INPUT                   | <ul style="list-style-type: none"> <li>• User cannot edit.</li> <li>• 0 = Stop</li> <li>• 1 = Run</li> </ul>   |
| <b>G311</b>                           | Displays the 4-20 mA analog input in mA.   |
| VIEW 4-20 ANALOG READING              | <ul style="list-style-type: none"> <li>• User cannot edit.</li> </ul>  |
| <b>G400</b>                           | Resets all settings to factory defaults. This menu appears only if the password is set to 99999 on menu G210. When "RESET" appears on the display, press and hold  for 2 seconds to reset the system. |
| RESET TO FACTORY DEFAULT              |  |

## Graco Motor Control Menu Quick Reference

|   |
|---|
| <b>G100 (View Events)</b><br>Displays the last 20 system event codes.   |
| <b>G101 (View or Reset Batch Volume)</b><br>Displays the batch volume that has been dispensed.  |
| <b>G102 (View Life Total)</b><br>Displays the total number of pump cycles for the life of the pump.   |
| <b>G130–G132 (View Maintenance Counters 1, 2, 3)</b><br>Displays the number of pump cycles since the last maintenance.  |
| <b>G200 (Set Control Mode)</b><br>0 = Flow Control (default)<br>1 = Batch Control   |
| <b>G201 (Set Flow Units)</b><br>0 = cpm, default<br>1 = gpm<br>2 = lpm  |
| <b>G203 (Set Pump K-Factor)</b><br>Range: 262 — 785 cc/cycle<br>Default: 523 cc/cycle   |
| <b>G204 (Enable Max Power)</b><br>0 = Disabled – 12A (Default)<br>1 = Disabled – 16A<br>2 = Enabled – 12A<br>3 = Enabled – 16A  |
| <b>G206 (Set Leak Detection Type)</b><br>0 = Disabled (Default)<br>1 = Deviation<br>2 = Alarm   |
| <b>G207 (Set Maximum Acceleration)</b><br>Range: 1-300 seconds<br>Default: 20 seconds   |
| <b>G208 (Set Maximum Deceleration)</b><br>Range: 1-300 seconds<br>Default: 1 second   |
| <b>G209 (Configure External Control)</b><br>0 = Disabled (Default)<br>1 = Stop Only (Manual Start)<br>2 = Start/Stop (Full Remote)<br>3 = Full Control (Both Start/Stop and Flow) |
| <b>G210 (Set or Disable Password)</b><br>Range: 1-99999<br>Default: 0   |
| <b>G212 (Set 4–20 Analog Low Input)</b><br>Range: 4.0 – 20.0 mA<br>Default: 4.0 mA  |
| <b>G213 (Set 4–20 Analog High Input)</b><br>Range: 4.0 – 20.0 mA<br>Default: 20 mA  |

|   |
|---|
| <b>G230–G232 (Set Maintenance Counters 1, 2, 3)</b><br>Range: 0.1 — 99.9 million cycles<br>Default: 0 |
| <b>G240 (Set Minimum Flow Setpoint)</b><br>Range: 0–280 cpm<br>Default: 0                             |
| <b>G241 (Set Maximum Flow Setpoint)</b><br>Range: 0–280 cpm<br>Default: 280                           |
| <b>G245 (Set Minimum Volume Setpoint)</b><br>Range: 0–9999 cycles<br>Default: 0                       |
| <b>G246 (Set Maximum Volume Setpoint)</b><br>Range: 0–9999 cycles<br>Default: 9999                    |
| <b>G247 (Batch Mode Target Flow)</b><br>Range: 0–280 cpm<br>Default: 0                                |
| <b>G300 (View Flow Rate)</b><br>Displays the pump flow rate.  |
| <b>G302 (View BUS Voltage)</b><br>Displays the BUS voltage in V.                                      |
| <b>G303 (View Motor Voltage)</b><br>Displays the RMS motor voltage in V.                              |
| <b>G304 (View Motor Current)</b><br>Displays the RMS motor current in A.                              |
| <b>G305 (View Motor Power)</b><br>Displays the motor power in W.                                      |
| <b>G306 (View Controller Temperature)</b><br>Displays the IGBT temperature in °C.                     |
| <b>G307 (View Motor Temperature)</b><br>Displays the motor temperature in °C.                         |
| <b>G308 (View Software Information)</b><br>Displays the software version and serial number.           |
| <b>G309 (View Leak Sensor Input)</b><br>0 = No Leak Detected<br>1 = Leak Detected                     |
| <b>G310 (View Run/Stop Input)</b><br>0 = Stop<br>1 = Run  |
| <b>G311 (View 4–20 Analog Reading)</b><br>Displays the 4-20 mA analog input in mA.                    |
| <b>G400 (Reset to Factory Defaults)</b><br>Resets all settings to factory defaults.                   |

## Maintenance

|  |   |   |   |  |
|--|---|---|---|--|
|   |  |  |  |  |
| <p>To avoid injury from fire, explosion, or electric shock, all electrical wiring must be done by a qualified electrician and comply with all local codes and regulations.</p> |   |   |   |  |

### Maintenance Schedule

Establish a preventive maintenance schedule based on the pump's service history. Scheduled maintenance is especially important to prevent spills or leakage due to diaphragm failure.

### Lubrication

The pump is lubricated at the factory. It is designed to require no further lubrication for the life of the bearings.

### Tighten Connections

Before each use, check all hoses for wear or damage and replace as necessary. Check to be sure all connections are tight and leak-free.

### Clean the Graco Motor Control

Keep the heat sink fins clean at all times. Clean them using compressed air.

**NOTE:** Do not use conductive cleaning solvents on the module.

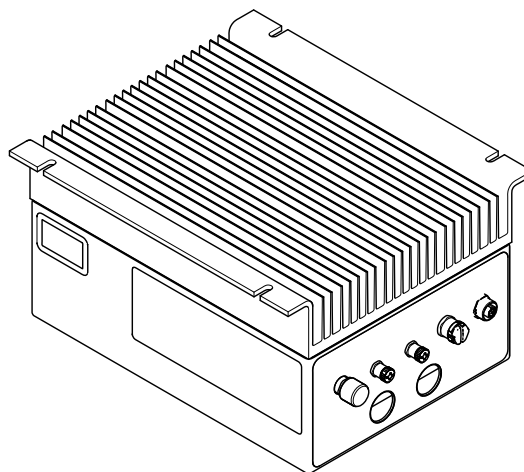

ti25595a

### Upgrade Graco Motor Control Software

Use Software Upgrade Kit 17H104 and Programming Cable Kit 24Y788 to update the Graco Motor Control software. The kits include instructions and all necessary parts.

## Flushing and Storage



To avoid fire and explosion, always ground equipment and waste container. To avoid static sparking and injury from splashing, always flush at the lowest possible pressure.

Insert suction tube into cleaning solution. Open air regulator to supply low pressure air to the pump. Run the pump long enough to thoroughly clean the pump and hoses. Close the air regulator. Remove the suction tube from the cleaning solution and drain pump. Place suction tube in the fluid to be pumped.

Flush the pump often enough to prevent the fluid you are pumping from drying or freezing in the pump

and damaging it. Flushing schedule will be based on what the pump is being used for. Use a compatible cleaning solution and always cycle the pump during the entire flushing process.

Always flush the pump and relieve the pressure before storing it for any length of time.

### **NOTICE**

Flush the pump often enough to prevent the fluid you are pumping from drying or freezing in the pump and damaging it. Store the pump at 32°F (0°C) or higher. Exposure to extreme low temperatures may result in damage to plastic parts.

# Troubleshooting the Graco Motor Control

| Problem  | Cause   | Solution  |
|--|---|---|
| Motor does not spin (chatters) and Event code is F1DP, F2DP, or WMC0.  | Motor leads are wired incorrectly.  | <ul style="list-style-type: none"> <li>• Correctly wire motor according to wiring diagram.</li> </ul>   |
| Motor does not spin (chatters) and Event code is T6E0, K6EH, or K9EH.  | Feedback cable is disconnected.   | <ul style="list-style-type: none"> <li>• Ensure the motor feedback cable is securely connected to both the motor and Connector 1 of the controller.</li> <li>• Remove any external EMI sources if receiving K9EH.</li> <li>• Route feedback cable away from motor power cabling.</li> </ul> |
| Motor does not run at full speed.<br>(Event Codes F1DP, F2DP, V1CB, V9CB)  | Input voltage is low.   | <ul style="list-style-type: none"> <li>• Ensure the line voltage is at least 108/216 VAC.</li> <li>• Reduce backpressure.</li> <li>• Change input voltage from 120 VAC to 240 VAC.</li> </ul>   |
| <p>Motor is hot.</p>  <p>(Event Codes F2DT, T3E0, or T4E0<br/>G307 &gt; 100°C)</p>  | System is running outside of the acceptable range for continuous operation. | <ul style="list-style-type: none"> <li>• Reduce the pump back pressure, flow rate, or duty cycle.</li> <li>• Add external cooling to motor (fan).</li> <li>• If receiving T4E0, Max Power Mode can be enabled to automatically reduce pump performance to eliminate overheating.</li> </ul> |
| Membrane buttons do not work or membrane switch works intermittently.  | Membrane switch is disconnected.  | <ul style="list-style-type: none"> <li>• Ensure the ribbon cable is correctly inserted into the Control board.</li> </ul>   |
| PLC control is intermittent or does not function; or Event Codes K6EH, K9EH, L3X0, L4X0 are displayed.   | Ribbon cable is disconnected.   | <ul style="list-style-type: none"> <li>• Ensure the ribbon cable between the Control board and the Connector board is correctly inserted.</li> </ul>  |
| The display is not illuminated or displays intermittently.   | Display cable is disconnected.  | <ul style="list-style-type: none"> <li>• Ensure the ribbon cable and clip are securely installed in the Control Board.</li> </ul>   |
| <ul style="list-style-type: none"> <li>• Control shuts down/resets when cabling is connected to Connector 3.</li> <li>• The Green LED on the Control board or the Power board is off, dimly lit, or blinking.</li> <li>• The Red LED on the Control board is dimly lit or blinking.</li> </ul> | 5V supply has shorted.  | <ul style="list-style-type: none"> <li>• Disconnect Connector 3.</li> <li>• Correct miswiring.</li> <li>• Reduce current draw on Connector 3 – Pin 1.</li> </ul>  |
|  | Internal power supply has failed.   | <ul style="list-style-type: none"> <li>• Disconnect Connector 3 to validate the 5V supply isn't shorted.</li> <li>• Contact Graco Technical Support.</li> </ul>   |
| G200 menus are not displayed after entering password.  | An incorrect password has been entered.                                     | <ul style="list-style-type: none"> <li>• Enter the correct password.</li> <li>• Contact Graco Technical Support for instructions on resetting a password.</li> </ul>  |
| GFCI breaker trips when motor is run.  | Leakage current exceeds breaker limit.                                      | <ul style="list-style-type: none"> <li>• Controller is not compatible with all GFCI circuits.</li> <li>• Connect control to non GFCI circuit or an appropriate industrial GFCI circuit.</li> </ul>  |

## Diagnostic Information

Table 6 LED Status Signal

| Module Status LED Signal | Description  | Solution                                |
|--------------------------|--|---|
| No LEDs                  | No system power.                                       | Apply system power.                     |
| Green on                 | System is powered up.                                  | —                                       |
| Yellow on                | Communication with external GCA device is in progress. | —                                       |
| Red solid                | Graco Motor Control hardware failure.                  | Replace the Graco Motor Control.        |
| Red flashing fast        | Uploading software.                                    | Wait until software upload is complete. |
| Red flashing slow        | Bootloader error or error in software upload.          | Contact Graco technical support.        |

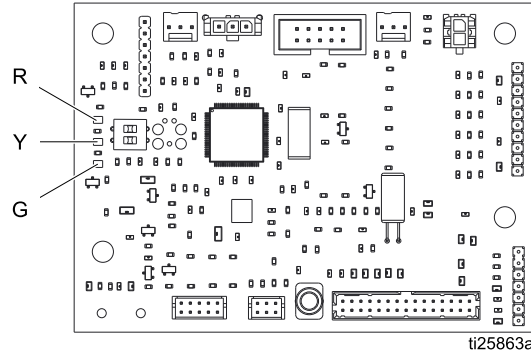

Figure 10 Control Board

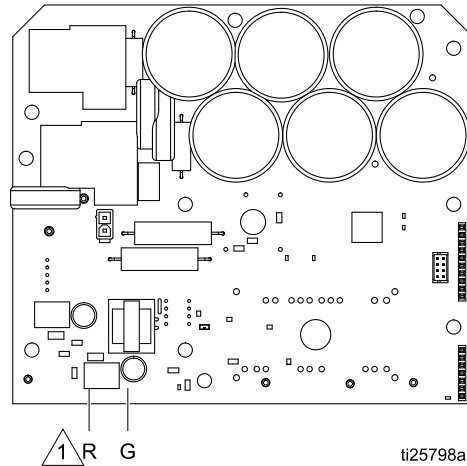

Figure 11 Power Board

1 The red LED is on the back of the board.

## Power Line Voltage Surges

Power conversion equipment can be sensitive to voltage fluctuations from the incoming power supply. The Graco Motor Control is considered to be power conversion equipment because energy is stored on a capacitive bus and then modulated to control a brush-less motor. The design of the Graco Motor Control takes this into account, and therefore can withstand a wide range of conditions. However, it is still possible for supplied power to occasionally go outside of the tolerable range in industrial plants with high-amperage reactive pulsed loads, such as welding equipment.

If the tolerable range is exceeded, an over-voltage condition is flagged and the system shuts down in an alarm state for protection and to alert the user of unstable power. Excessive or repeated over-voltage events may permanently damage the hardware.

The MAX-HOLD feature on a multimeter can be used to determine peak DC voltage on the line. DC is the correct setting, as opposed to AC, because peak voltage is the critical parameter that affects the DC voltage level stored on the capacitive bus in power conversion equipment.

Readings should not regularly exceed approximately 400 Vdc to avoid tripping the 420 Vdc alarm level in the Graco Motor Control. If the power quality is suspect, it is recommended to power condition or isolate the device(s) that is causing the poor power quality. Consult a qualified electrician if there are any concerns about the available power supply.

## Test Power Line with Multimeter

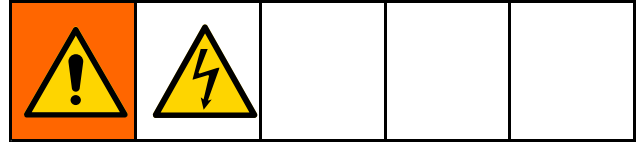

1. Set multimeter to DC voltage.
2. Connect the multimeter probes to the supplied power line.
3. Press Min Max successively to show the peak positive and the negative DC voltages.
4. Confirm that readings do not exceed 400 Vdc (Graco Motor Control alarm is issued at 420 Vdc).

## Events

The LED displays event codes to inform the user of any electrical hardware or software problems. After the user acknowledges the error, if the condition is still present in the system:

- **Run Mode:** The display alternates between the event code and the regular display.
- **Setup Mode:** The event code does not display.

Four types of events can occur. All four types are logged and can be viewed on G100.

- **ALARM:** The system immediately stops the pump and displays an event code. The event requires attention and will continue to flash alternately on the Run screen until the operator corrects the condition and clears the alarm.

- **DEVIATION:** The pump continues to run. The event requires attention and will continue to flash alternately on the Run screen until the operator corrects the condition and clears the alarm.
- **ADVISORY:** The event flashes on the Run screen for one minute and is logged. The pump continues to run and the event does not require operator attention.
- **RECORD:** The event is logged but does not display. The pump continues to run and the event does not require operator attention.

| Event Code | Event Level | Description  | Solution  |
|------------|-------------|--|---|
| A4CH       | Alarm       | Motor current has exceeded the hardware limit.   | Check operating conditions to determine the source of the alarm. Event will clear after acknowledgment. |
| A4CS       | Alarm       | Motor current has exceeded the software limit.   | Check operating conditions to determine the source of the alarm. Event will clear after acknowledgment. |
| CACC       | Alarm       | A communication problem has been detected on the Control board.  | Check the connection between the Control and Power boards.  |
| CACH       | Alarm       | A communication problem has been detected on the Power board.  | Check the connection between the Control and Power boards.  |
| EBC0       | Deviation   | The pumping process has been interrupted. The pump is decelerating or batching and is commanded to stop.   | Event will clear after acknowledgment. Do not interrupt the process.                                    |
| EBG0       | Alarm       | The local Stop button was pressed on a system set for Remote Start/Stop Control, or Full Remote Control. The local button overrides the external control.  | Press the Start button to clear Alarm and resume remote control.  |
| ES00       | Record      | All memory has been erased and the settings have been set to factory defaults.   | None.   |
| F1DP       | Alarm       | The motor control limit has been reached and Max Power Mode is disabled in menu G204. The controller is at maximum line current, maximum motor current, or maximum output voltage and cannot maintain the flow setpoint. | Reduce pump flow/pressure. Enable Max Power Mode (menu G204).   |



| Event Code | Event Level | Description  | Solution  |
|------------|-------------|--|---|
| F2DP       | Deviation   | The motor control limit has been reached and Max Power Mode is enabled in menu G204. The controller is at maximum line current, maximum motor current, or maximum output voltage, but the motor will continue to run at a reduced performance. | Reduce pump flow/pressure.  |
| F2DT       | Deviation   | The motor temperature is above 120°C (248°F) and Max Power Mode is enabled in menu G204. The output current is being limited, but the system will run at a reduced performance.  | Reduce pump flow/pressure or duty cycle.  |
| K4E0       | Alarm       | The motor speed has exceeded the maximum.  | Event will clear after acknowledgment. Check operating conditions to determine the source of the alarm. |
| K6EH       | Alarm       | The position sensor has read an invalid position, likely because it is not connected.  | Ensure the feedback cable is correctly installed and away from any external noise sources.              |
| K9EH       | Deviation   | Position errors (skips, momentary invalid positions) have been detected. Likely due to noise on the motor feedback cable.  | Ensure the feedback cable is correctly installed and away from any external noise sources.              |
| L3X0       | Deviation   | The pump leak sensor has detected a leak and the Pump Leak Type is set to Deviation in G206. The pump continues to run.  | Replace worn parts to stop leak, drain leak sensor and replace.   |
| L4X0       | Alarm       | The pump leak sensor has detected a leak and the Pump Leak Type is set to Alarm in G206. The pump has been stopped.  | Replace worn parts to stop leak, drain leak sensor and replace.   |
| MA01       | Advisory    | The maintenance pump cycles have exceeded the number set on menu G230.   | Clear the Maintenance Counter (menu G130).  |
| MA02       | Advisory    | The maintenance pump cycles have exceeded the number set on menu G231.   | Clear the Maintenance Counter (menu G131).  |
| MA03       | Advisory    | The maintenance pump cycles have exceeded the number set on menu G232.   | Clear the Maintenance Counter (menu G132).  |
| T3E0       | Deviation   | The internal motor temperature is above 100°C (212°F).   | Reduce pump flow or duty cycle.   |
| T4C0       | Alarm       | The internal IGBT module temperature has exceeded the limit of 100°C (212°F).  | Reduce power output or decrease ambient temperature.  |
| T4E0       | Alarm       | The internal motor temperature is above 150°C (302°F) and Max Power Mode is disabled in G204.  | Reduce pump flow or duty cycle. Enable Max Power Mode (G204).   |

Troubleshooting the Graco Motor Control

| Event Code | Event Level | Description   | Solution  |
|------------|-------------|---|---|
| T6E0       | Alarm       | The motor is operating out of its temperature range or the temperature sensor signal is lost.       | Ensure that the motor ambient temperature is above minimum. Ensure that the feedback cable is correctly installed. Ensure the TO1/TO2 wires from the Control board are correctly inserted into the Connector board. Contact Graco technical assistance. |
| V1CB       | Alarm       | Bus voltage is below minimum acceptable limit.  | Check the voltage source level.   |
| V2CG       | Deviation   | IGBT Gate drive voltage is below minimum acceptable limit.  | Contact Graco technical assistance.   |
| V4CB       | Alarm       | Bus voltage is above maximum acceptable limit.  | Increase pump deceleration time. Check the voltage source level.  |
| V9CB       | Alarm       | Bus voltage measurement circuit is reporting abnormally low values when AC power is detected.       | Check the voltage source level. Contact Graco technical assistance.   |
| V9MX       | Alarm       | Loss of AC power has been detected.   | Reconnect AC power.   |
| WMC0       | Alarm       | The controller is not able to turn the motor (locked rotor).  | Free the motor rotor, then restart the motor.   |
| WSCF       | Alarm       | A Start command was received but the target flow rate is set to 0.                                  | Go the Run Screen and set a target flow rate.   |
| WSCS       | Alarm       | The software version or part number reported by the Power board does not match the expected values. | If a software upgrade has recently failed/ been interrupted, try again. If not, contact Graco technical assistance.   |
| WX00       | Alarm       | An unexpected software error has occurred.  | Event will clear after acknowledgment. Contact Graco technical assistance.  |

# Performance Charts

**Test Conditions:** The pump was tested in water with the inlet submerged. The air pressure was set 10 psi (0.7 bar) higher than the outlet pressure.

**How to Use the Charts**

1. Choose a flow rate and outlet pressure that falls below the Power Limit Curve. Conditions outside of the curve will decrease the life of the pump.

2. Set the VFD frequency corresponding to the desired flow rate. Flow rates will increase with outlet pressure lower than 10 psi (0.7 bar) and with high inlet head pressure.
3. To prevent inlet cavitation erosion, the *Net Positive Suction Head Available (NPSHa)* of your system should be above the *Net Positive Suction Head Required (NPSHr)* line shown on the chart.

## Pump with AC gearmotor and 2HP VFD

Motor and gearbox configuration codes [A04A](#) & [S04A](#)

**KEY**

- A** Power Limit Curve
- B** Net Positive Suction Head Required

The shaded area is recommended for continuous duty.

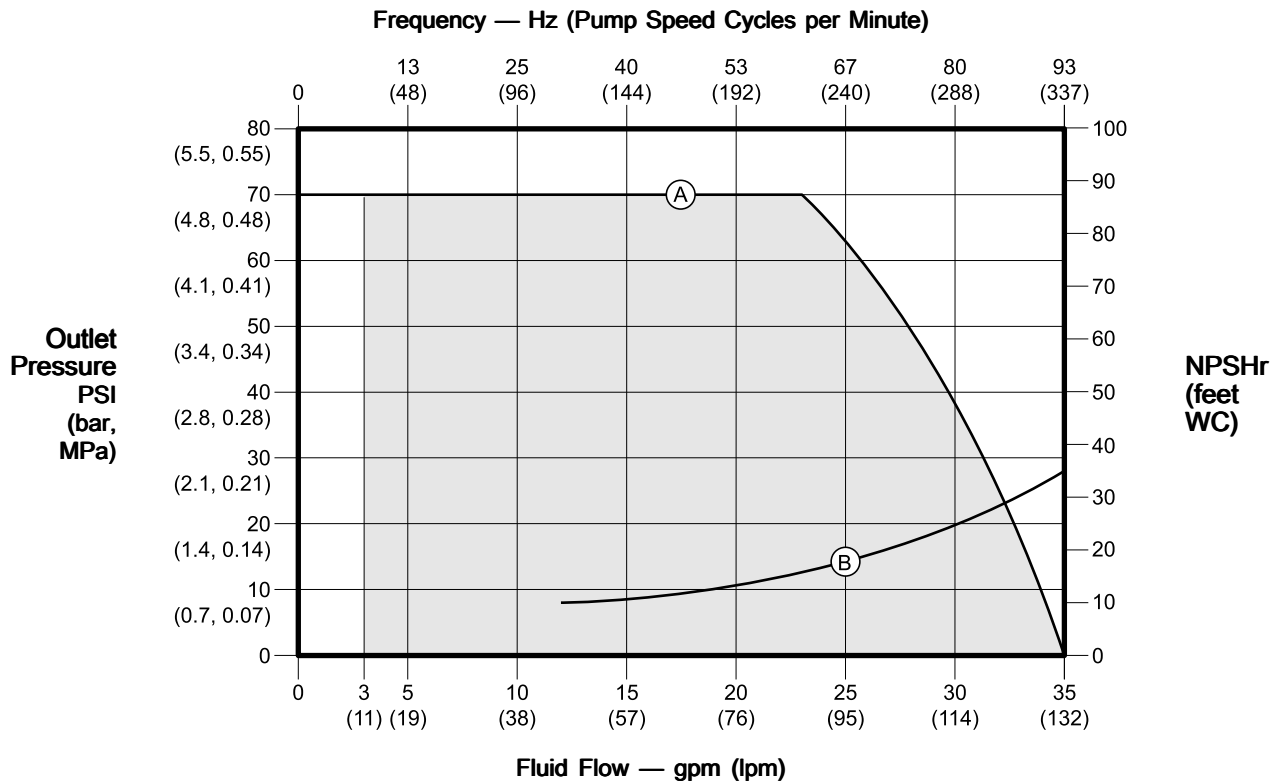

### Pump with BLDC Motor

Motor and gearbox configuration codes **A04B** & **S04B**

**KEY**

- A** Power Limit Curve
- B** Net Positive Suction Head Required

The shaded area is recommended for continuous duty.

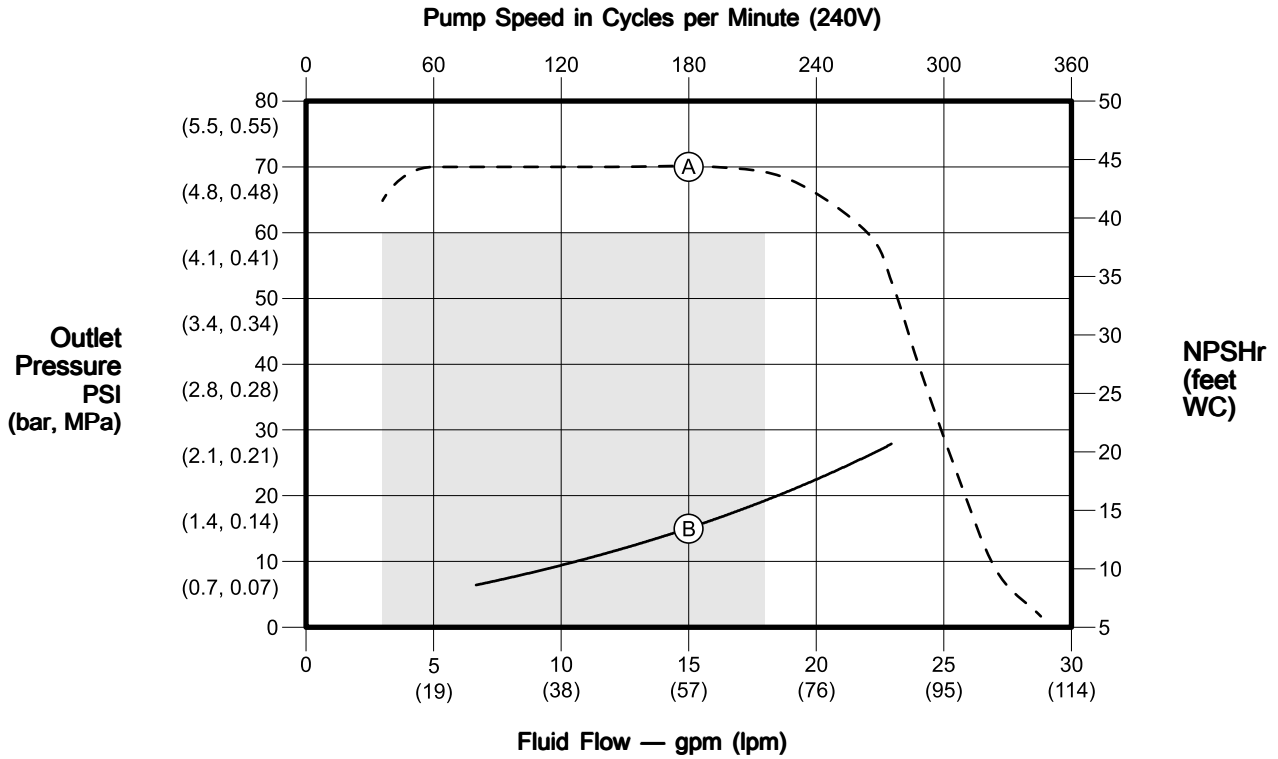

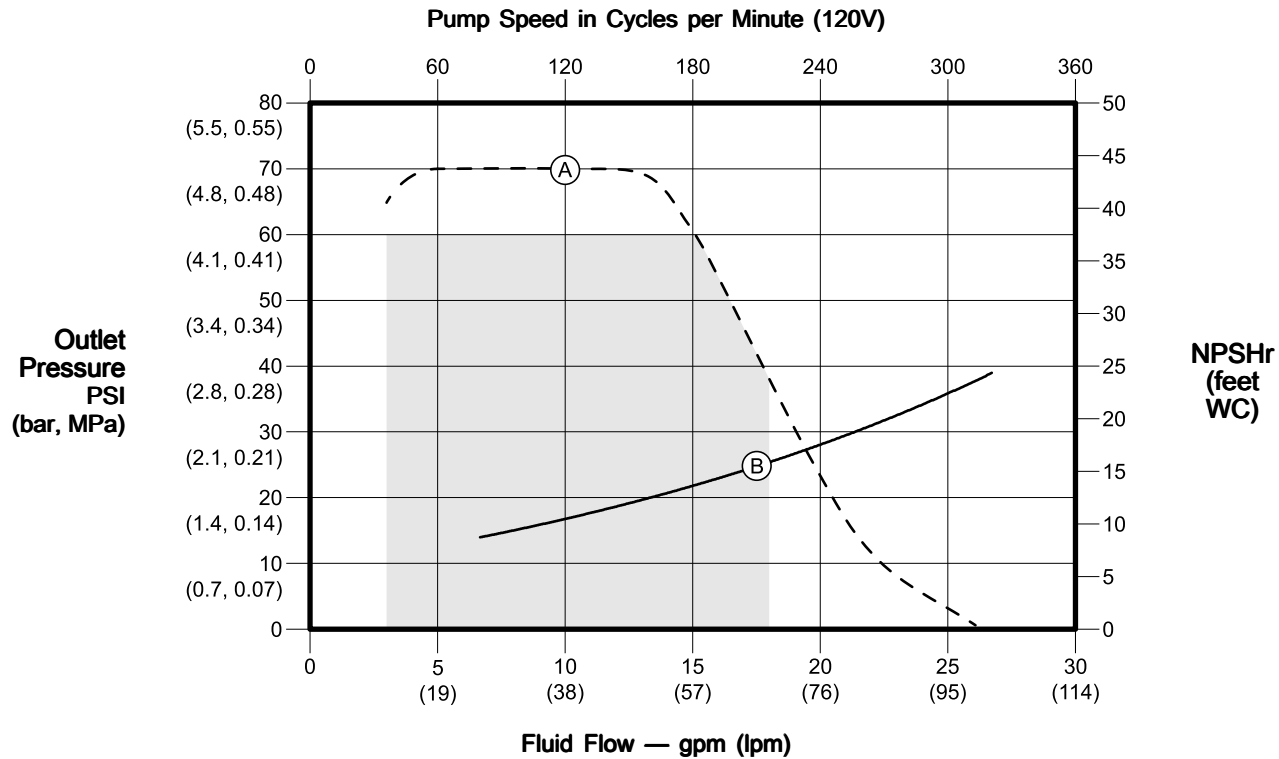

## ATEX motor and 18:1 Gearbox

Good for 2-pole, 3600 RPM, 2HP motors (pump codes A04E, A04F)

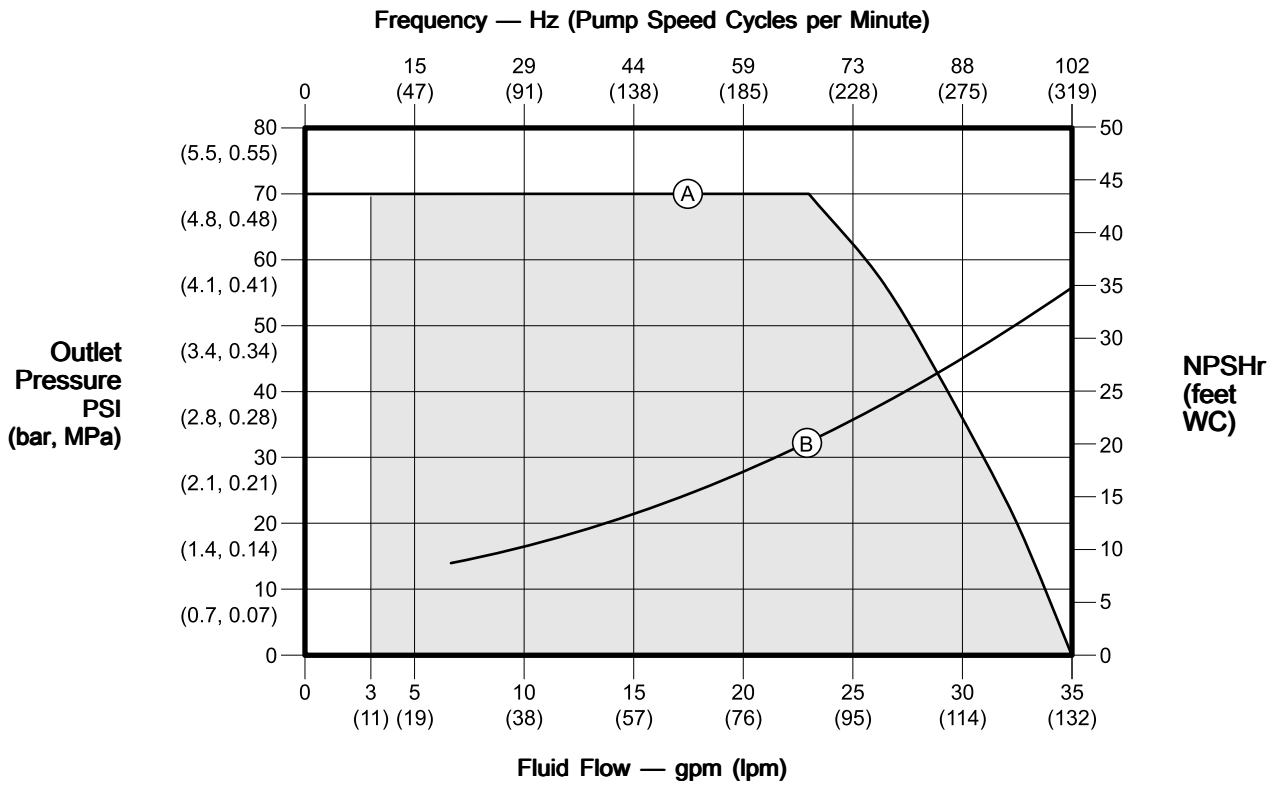

### Low-Pulsation Mode

Two typical running conditions are shown in the curves. The curves show the relationship between outlet pressure and outlet flow during Low Pulsation Mode (above the transition line) and Transfer Mode (below the transition line). Adjust the pump speed and air pressure to achieve the desired result.

#### KEY

- A** 20 Hz, 73 cycles per minute
- B** 40 Hz, 145 cycles per minute
- C** 60 Hz, 217 cycles per minute
- D** 20 psi (1.4 bar) air pressure
- E** 40 psi (2.8 bar) air pressure
- F** 60 psi (4.1 bar) air pressure
- G** Transition line (Low Pulsation Mode is shaded.)

### Frequency

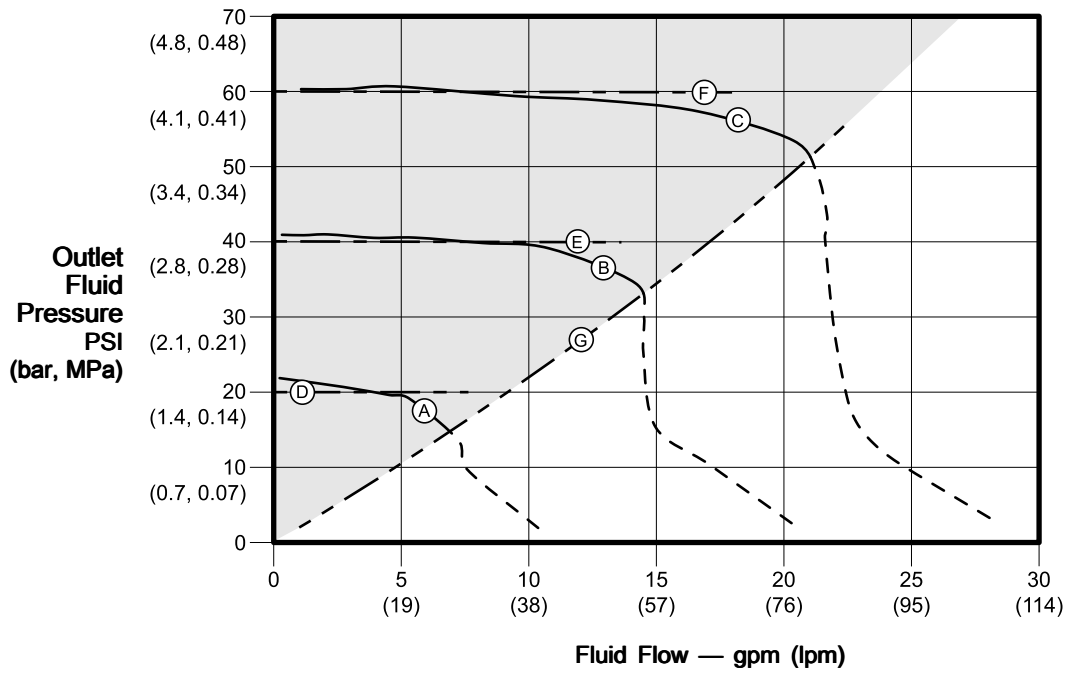

## How to Calculate Your System's Net Positive Suction Head – Available (NPSHa)

For a given flow rate, there must be a minimum fluid head pressure supplied to the pump to prevent cavitation. This minimum head is shown on the Performance Curve, labeled as NPSHr. The units are feet WC (Water Column) absolute. The NPSHa

of your system must be greater than the NPSHr to prevent cavitation and therefore increase efficiency and the life of your pump. To calculate the NPSHa of your system, use the following equation:

$$\text{NPSHa} = H_a \pm H_z - H_f - H_{vp}$$

**Where:**

**H<sub>a</sub>** is the absolute pressure on the surface of the liquid in the supply tank. Typically, this is atmospheric pressure for a vented supply tank, e.g. 34 feet at sea level.

**H<sub>z</sub>** is the vertical distance in feet between the surface of the liquid in the supply tank and the centerline of the pump inlet. Value should be positive if the level is higher than the pump and negative if the level is lower than the pump. Always be sure to use the lowest level the liquid can reach in the tank.

**H<sub>f</sub>** is the total of the friction losses in the suction piping.

**H<sub>vp</sub>** is the absolute vapor pressure of the liquid at the pumping temperature.





# Dimensions

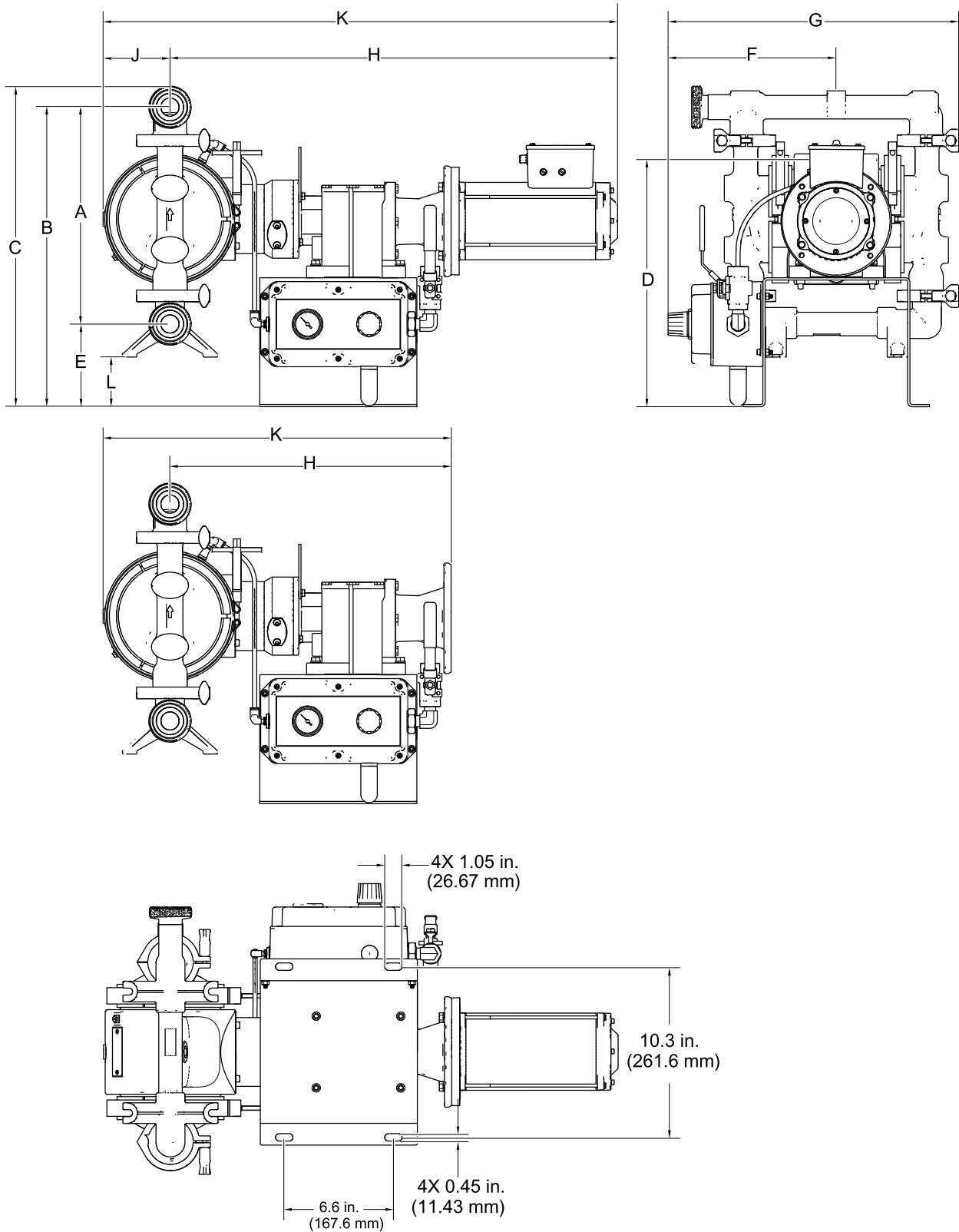
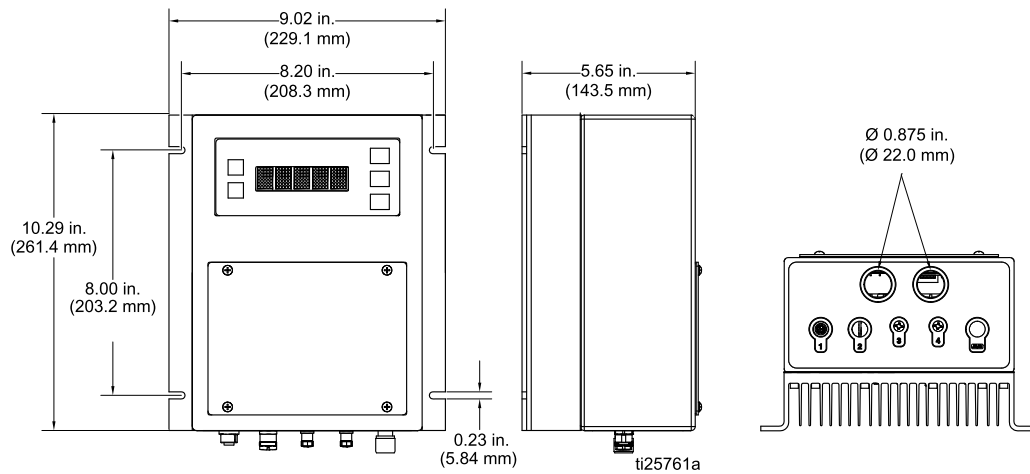

Figure 12 Pumps without Compressor (BLDC and motorless models shown)

Table 7 Dimensions for Aluminum Pumps

| Ref. | Gearbox and Motor |      |               |      | Gearbox Only |      |
|------|-------------------|------|---------------|------|--------------|------|
|      | AC<br>(04A)       |      | BLDC<br>(04B) |      | 04E & 04F    |      |
|      | in                | cm   | in            | cm   | in           | cm   |
| A    | 13.1              | 33.3 | 13.1          | 33.3 | 13.1         | 33.3 |
| B    | 18.1              | 46.0 | 18.1          | 46.0 | 18.1         | 46.0 |
| C    | 19.1              | 48.5 | 19.1          | 48.5 | 19.1         | 48.5 |
| D    | 15.5              | 39.4 | 14.5          | 39.4 | NA           | NA   |
| E    | 5.0               | 12.7 | 5.0           | 12.7 | 5.0          | 12.7 |
| F    | 10.2              | 25.9 | 10.2          | 25.9 | 10.2         | 25.9 |
| G    | 17.6              | 44.7 | 17.6          | 44.7 | 17.6         | 44.7 |
| H    | 24.9              | 63.2 | 27.1          | 63.2 | 17.0         | 43.2 |
| J    | 4.0               | 10.2 | 4.0           | 10.2 | 4.0          | 10.2 |
| K    | 28.9              | 73.4 | 31.1          | 73.4 | 21.0         | 53.3 |
| L    | 3.0               | 7.6  | 3.0           | 7.6  | 3.0          | 7.6  |

Graco Motor Control Dimensions



Dimensions

Cart System Dimensions

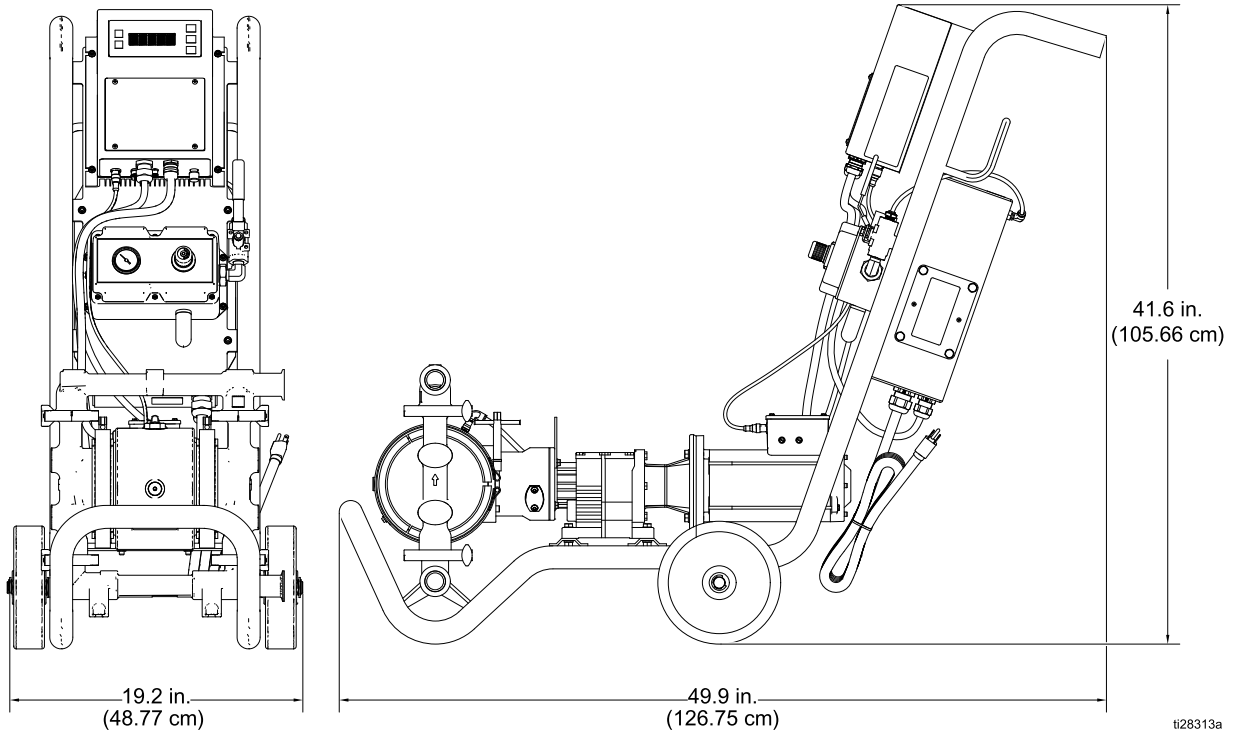

Compressor Dimensions

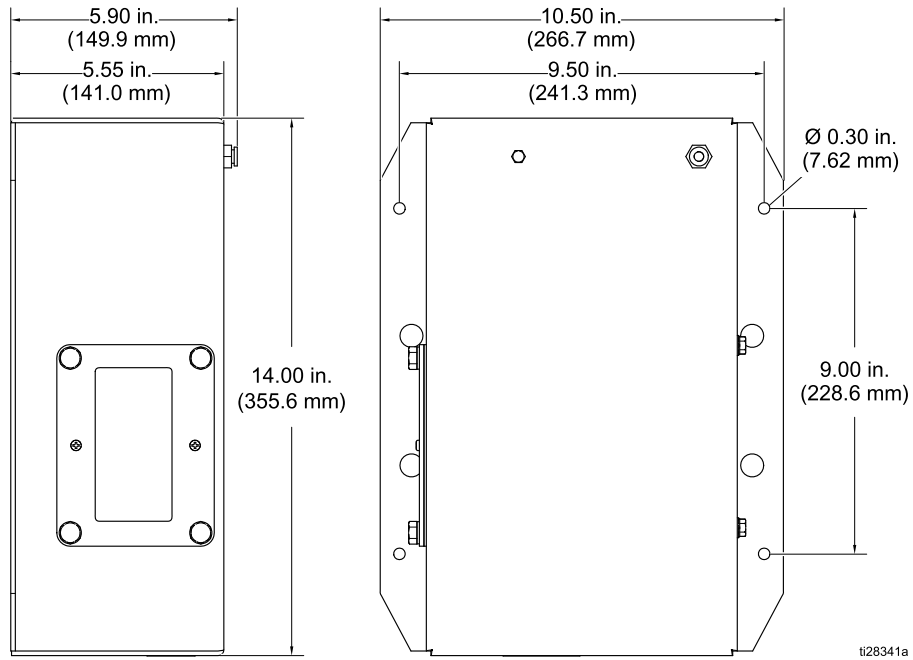

# Technical Data

|  | US   | Metric                           |
|--|--|----------------------------------|
| <b>SaniForce 1040e Electric-Operated Double Diaphragm Pump</b>   |  |                                  |
| Maximum fluid working pressure   | 70 psi                                     | 0.48 MPa, 4.8 bar                |
| Air pressure operating range   | 20 to 80 psi                               | 0.14 to 0.55 MPa, 1.4 to 5.5 bar |
| Air inlet size   | 3/8 in. npt(f)                             |                                  |
| Maximum suction lift (reduced if balls don't seat well due to damaged balls or seats, lightweight balls, or extreme speed of cycling)                | Wet: 29 ft<br>Dry: 16 ft                   | Wet: 8.8 m<br>Dry: 4.9 m         |
| Maximum size pumpable solids   | 1/8 in.                                    | 3.2 mm                           |
| Ambient air temperature range for operation and storage.<br><b>NOTE:</b> Exposure to extreme low temperatures may result in damage to plastic parts. | 32° F–104° F                               | 0° C–40° C                       |
| Fluid displacement per cycle   | 0.10 gallons                               | 0.38 liters                      |
| Maximum free-flow delivery   | 35 gpm*                                    | 132.5 lpm*                       |
| Maximum pump speed   | 280 cpm                                    |                                  |
| <b>Fluid Inlet and Outlet Size</b>   |  |                                  |
| Aluminum and Stainless Steel   | 1.5 in. sanitary flange or 40 mm DIN 11851 |                                  |
| <b>Electric Motor</b>  |  |                                  |
| AC, Standard CE (04A)  |  |                                  |
| Power  | 2 HP                                       |                                  |
| Speed  | 1800 rpm (60 Hz) or 1500 rpm (50 Hz)       |                                  |
| Gear Ratio   | 8.16                                       |                                  |
| Voltage  | 3-phase 230V / 3-Phase 460V                |                                  |
| BLDC (04B)   |  |                                  |
| Power  | 2.2 HP                                     |                                  |
| Speed  | 3600 rpm                                   |                                  |
| Gear Ratio   | 11.86                                      |                                  |
| Voltage  | 320 VDC                                    |                                  |
| <b>Motorless Gearbox</b>   |  |                                  |
| NEMA (04E)   |  |                                  |
| Mounting Flange  | NEMA 56 C                                  |                                  |
| Gear Ratio   | 18.08                                      |                                  |
| IEC (04F)  |  |                                  |
| Mounting Flange  | IEC 90                                     |                                  |
| Gear Ratio   | 18.08                                      |                                  |
| <b>Noise Data</b>  |  |                                  |
| Sound Power (measured per ISO-9614-2)  |  |                                  |
| at 70 psi fluid pressure and 50 cpm  | 71 dBa                                     |                                  |
| at 30 psi fluid pressure and 280 cpm (full flow)   | 94 dBa                                     |                                  |

Technical Data

|  | US     | Metric |
|--|--------|--------|
| Sound Pressure [tested 3.28 ft (1 m) from equipment] |        |        |
| at 70 psi fluid pressure and 50 cpm                  | 61 dBa |        |
| at 30 psi fluid pressure and 280 cpm (full flow)     | 84 dBa |        |

\* Varies by pump model. See performance charts for your model.

## Weights

| Pump Material   |                 | Motor/Gearbox |    |      |    |     |    |            |    |
|-----------------|-----------------|---------------|----|------|----|-----|----|------------|----|
| Fluid Section   | Center Section  | AC            |    | NEMA |    | IEC |    | BLDC+ NEMA |    |
|                 |                 | lb            | kg | lb   | kg | lb  | kg | lb         | kg |
| Stainless Steel | Aluminum        | 136           | 62 | 99   | 45 | 104 | 47 | 120        | 54 |
| Stainless Steel | Stainless Steel | 166           | 75 | 129  | 58 | 134 | 61 | 150        | 68 |

|   | US   | Metric |
|---|--|--------|
| <b>Weight</b>   |  |        |
| Compressor  | 28 lb  | 13 kg  |
| Graco VFD   | 6 lb   | 3 kg   |
| Graco Motor Control   | 10.5 lb  | 4.8 kg |
| Cart  | 33 lb  | 15 kg  |
| <b>Wetted Parts</b>   |  |        |
| Wetted parts include stainless steel, plus material(s) chosen for seat, ball, and diaphragm options |  |        |
| Non-wetted parts  |  |        |
| Aluminum  | aluminum, coated carbon steel, bronze                  |        |
| Stainless Steel   | stainless steel, aluminum, coated carbon steel, bronze |        |

## Fluid Temperature Range

| <b>NOTICE</b>   |
|---|
| Temperature limits are based on mechanical stress only. Certain chemicals will further limit the fluid temperature range. Stay within the temperature range of the most-restricted wetted component. Operating at a fluid temperature that is too high or too low for the components of your pump may cause equipment damage. |

| Diaphragm/Ball/Seat Material                                      | Fluid Temperature Range |              |
|---|-------------------------|--------------|
|   | Fahrenheit              | Celsius      |
| Polychloroprene check balls (CW)                                  | 40° to 200°F            | 4° to 90°C   |
| PTFE overmolded diaphragm (PO)                                    | 40° to 220°F            | 4° to 104°C  |
| PTFE check balls or two-piece PTFE/EPDM diaphragm (PT)            | 40° to 220°F            | 4° to 104°C  |
| Santoprene® check balls or 2-piece PTFE/Santoprene diaphragm (SP) | -40° to 180°F           | -40° to 82°C |

**Technical Specifications for the Graco Motor Control**

|  |  |              |
|--|--|--------------|
| DC Power Supply                          | Class 2 Power Supply only  |              |
| Approvals                                | UL508C   |              |
| Conformity                               | CE-Low Voltage (2006/95/EC), EMC (2004/108/EC), and RoHS (2011/65/EU) Directives |              |
| Ambient Temperature                      | -40°F – 104°F  | -40°C – 40°C |
| Environment Rating                       | Type 4X, IP 66   |              |
| Overtemperature Sensing Specifications   | 0–3.3 VDC, 1mA maximum   |              |
| <b>Input Specifications</b>              |  |              |
| Input Line Voltage                       | 120/240 VAC, line-to-line  |              |
| Input Line Phasing                       | Single Phase   |              |
| Input Line Frequency                     | 50/60 Hz   |              |
| Input Current per Phase                  | 16A  |              |
| Maximum Branch Circuit Protection Rating | 20A, Inverse Time Circuit Breaker  |              |
| Short Circuit Current Rating             | 5 kA   |              |
| <b>Output Specifications</b>             |  |              |
| Output Line Voltage                      | 0–264 VAC  |              |
| Output Line Phasing                      | Three Phase  |              |
| Output Current                           | 0–12A  |              |
| Output Power                             | 1.92 KW / 2.6 HP   |              |
| Output Overload                          | 200% for 0.2 seconds   |              |

Drive is provided with a means to accept and act upon a signal from a thermal sensor in the motor. Motor overtemperature sensing is required in order to provide the motor overload protection.

Current limit, set via the software, is provided as a secondary protection from motor overload.

All installations and wiring must comply with NEC and local electrical codes.

# Graco Standard Warranty

Graco warrants all equipment referenced in this document which is manufactured by Graco and bearing its name to be free from defects in material and workmanship on the date of sale to the original purchaser for use. With the exception of any special, extended, or limited warranty published by Graco, Graco will, for a period of twelve months from the date of sale, repair or replace any part of the equipment determined by Graco to be defective. This warranty applies only when the equipment is installed, operated and maintained in accordance with Graco's written recommendations.

This warranty does not cover, and Graco shall not be liable for general wear and tear, or any malfunction, damage or wear caused by faulty installation, misapplication, abrasion, corrosion, inadequate or improper maintenance, negligence, accident, tampering, or substitution of non-Graco component parts. Nor shall Graco be liable for malfunction, damage or wear caused by the incompatibility of Graco equipment with structures, accessories, equipment or materials not supplied by Graco, or the improper design, manufacture, installation, operation or maintenance of structures, accessories, equipment or materials not supplied by Graco.

This warranty is conditioned upon the prepaid return of the equipment claimed to be defective to an authorized Graco distributor for verification of the claimed defect. If the claimed defect is verified, Graco will repair or replace free of charge any defective parts. The equipment will be returned to the original purchaser transportation prepaid. If inspection of the equipment does not disclose any defect in material or workmanship, repairs will be made at a reasonable charge, which charges may include the costs of parts, labor, and transportation.

**THIS WARRANTY IS EXCLUSIVE, AND IS IN LIEU OF ANY OTHER WARRANTIES, EXPRESS OR IMPLIED, INCLUDING BUT NOT LIMITED TO WARRANTY OF MERCHANTABILITY OR WARRANTY OF FITNESS FOR A PARTICULAR PURPOSE.**

Graco's sole obligation and buyer's sole remedy for any breach of warranty shall be as set forth above. The buyer agrees that no other remedy (including, but not limited to, incidental or consequential damages for lost profits, lost sales, injury to person or property, or any other incidental or consequential loss) shall be available. Any action for breach of warranty must be brought within two (2) years of the date of sale.

**GRACO MAKES NO WARRANTY, AND DISCLAIMS ALL IMPLIED WARRANTIES OF MERCHANTABILITY AND FITNESS FOR A PARTICULAR PURPOSE, IN CONNECTION WITH ACCESSORIES, EQUIPMENT, MATERIALS OR COMPONENTS SOLD BUT NOT MANUFACTURED BY GRACO.** These items sold, but not manufactured by Graco (such as electric motors, switches, hose, etc.), are subject to the warranty, if any, of their manufacturer. Graco will provide purchaser with reasonable assistance in making any claim for breach of these warranties.

In no event will Graco be liable for indirect, incidental, special or consequential damages resulting from Graco supplying equipment hereunder, or the furnishing, performance, or use of any products or other goods sold hereto, whether due to a breach of contract, breach of warranty, the negligence of Graco, or otherwise.

## FOR GRACO CANADA CUSTOMERS

The Parties acknowledge that they have required that the present document, as well as all documents, notices and legal proceedings entered into, given or instituted pursuant hereto or relating directly or indirectly hereto, be drawn up in English. Les parties reconnaissent avoir convenu que la rédaction du présente document sera en Anglais, ainsi que tous documents, avis et procédures judiciaires exécutés, donnés ou intentés, à la suite de ou en rapport, directement ou indirectement, avec les procédures concernées.

## Graco Information

For the latest information about Graco products, visit [www.graco.com](http://www.graco.com).  
For patent information, see [www.graco.com/patents](http://www.graco.com/patents).

**To place an order**, contact your Graco Distributor or call to identify the nearest distributor.

**Phone:** 612-623-6921 **or Toll Free:** 1-800-328-0211 **Fax:** 612-378-3505

All written and visual data contained in this document reflects the latest product information available at the time of publication.

Graco reserves the right to make changes at any time without notice.

Original Instructions. This manual contains English. MM 3A3167

**Graco Headquarters:** Minneapolis

**International Offices:** Belgium, China, Japan, Korea

**GRACO INC. AND SUBSIDIARIES • P.O. BOX 1441 • MINNEAPOLIS MN 55440-1441 • USA**  
**Copyright 2015, Graco Inc. All Graco manufacturing locations are registered to ISO 9001.**

[www.graco.com](http://www.graco.com)

Revision J, September 2017